

**FOR INFORMATION ONLY:
DO NOT MANUFACTURE
PARTS TO THIS DRAWING**

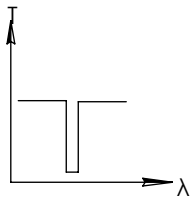
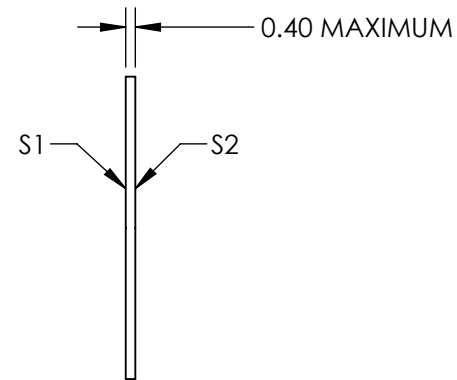
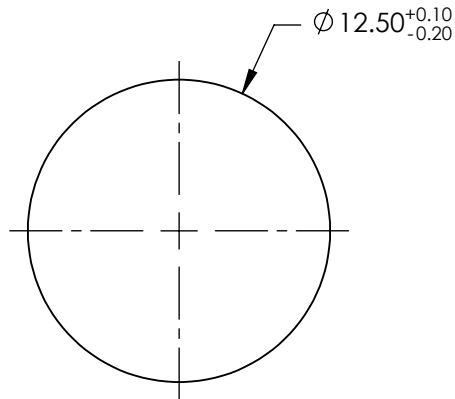
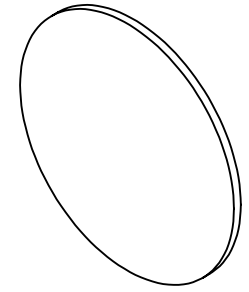

NOTCH FILTER

SPECIFICATIONS SUBJECT TO CHANGE WITHOUT NOTICE
DIMENSIONS ARE FOR REFERENCE ONLY

	VALUE
CLEAR APERTURE	$\varnothing 11.50$
CENTER WAVELENGTH	$1064 \pm 21.28 \text{nm}$
FULL WIDTH HALF MAX (FWHM)	$\leq 85.12 \text{nm}$
OPTICAL DENSITY	≥ 6.0
TRANSMISSION	$\geq 85\%$

EO® Edmund Optics®

THIRD ANGLE
PROJECTION

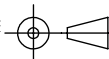

TITLE

1064nm, 12.5 mm Dia., OD 6.0 Ultra-Thin
Notch Filter

ALL DIMS IN

mm

DWG NO

14768

SHEET
1 OF 1