

NOTES:

1. MATERIAL:
HOUSING: BLACK ANODIZED ALUMINUM
LENS: BLACK DIAMOND BD-6

2. COATING (APPLY ACROSS COATING APERTURE)
BBAR (8000 - 12000nm)
R(AVG) < 0.75% @ 8000 - 12000nm

3. CLEAR APERTURE: 20.00mm

4. RoHS: COMPLIANT

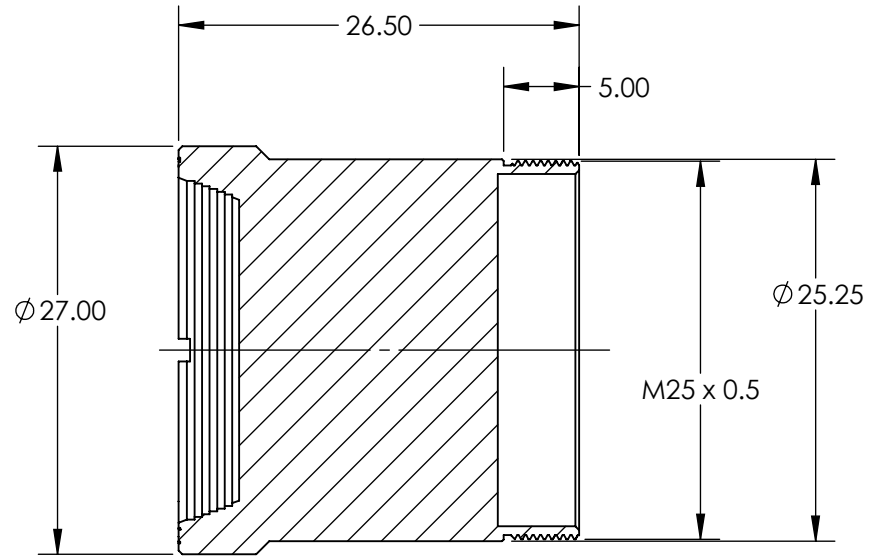
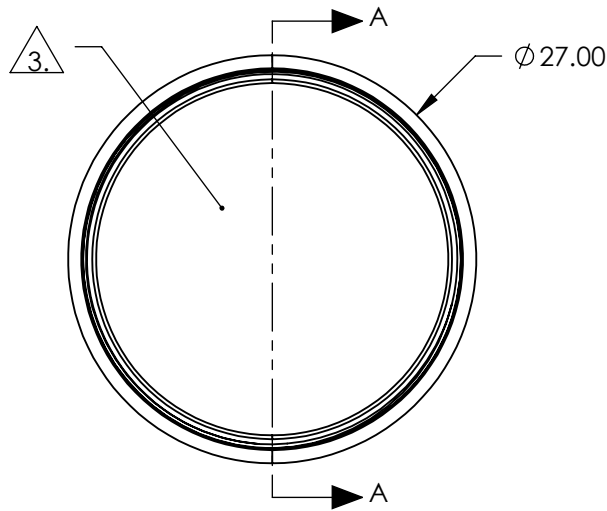

SECTION A-A

SPECIFICATIONS SUBJECT TO CHANGE WITHOUT NOTICE
DIMENSIONS ARE FOR REFERENCE ONLY

**FOR INFORMATION ONLY:
DO NOT MANUFACTURE
PARTS TO THIS DRAWING**

EO® Edmund Optics®

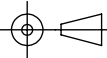
THIRD ANGLE PROJECTION 		TITLE	LIGHTPATH 7100346 24mm FL, f/1.2, THERMAL IMAGING LENS ASSEMBLY	
ALL DIMS IN	mm	DWG NO	15693	SHEET 1 OF 1