

[See all 24 Products in Family](#)

**TECHSPEC® 0.25X, 2/3" GoldTL™ Telecentric Lens**



#55-349 (0.25X)

Stock **#55-349 20+ In Stock**

⊖ 1 ⊕ €2.305<sup>00</sup>

**ADD TO CART**

Volume Pricing	
Qty 1+	€2.305,00 each
Need More?	<a href="#">Request Quote</a>

ⓘ Prices shown are exclusive of VAT/local taxes

Product Downloads

**General**

GoldTL™ Series **Product Family:**

**Stock No. of Mounting Clamp:**  
#56-026 Sold Separately

Telecentric Lens **Type:**

Focusable Telecentric **Special Type of Lens:**

## Physical & Mechanical Properties

Variable	Iris Option:
196.30	Length (mm):
196.30	Length excluding Threads (mm):
79.00	Maximum Diameter (mm):
1.44	Weight (kg):

## Optical Properties

35.2mm	Horizontal Field of View, 2/3" Sensor:
28.8mm	Horizontal Field of View, 1/1.8" Sensor:
25.6mm	Horizontal Field of View, 1/2" Sensor:
11.00	Maximum Image Circle (mm):
0.021	Numerical Aperture NA, Object Side:
>55% @40 lp/mm	Resolution, Image Space MTF @ f/10:
10 (7)	Number of Elements (Groups):
<0.040	Typical Telecentricity @ 588nm (°):
0.400	Typical Distortion @ 588nm (%):
0.25X	Primary Magnification PMAG:
0.25	Telecentric Lens Magnification:
161 - 186	Working Distance (mm):
35.2 x 26.4	FOV @ Max Sensor Format, H x V (mm):
f/6 - f/25	Aperture (f/#):
M4 MgF <sub>2</sub>	Coating:
±8.2 at f/10 (20% @20 lp/mm)	Depth of Field (mm):
0.25X	Magnification:
VIS	Lens Wavelength Range:

## Sensor

2/3"	Maximum Sensor Format:
2.74	Pixel Size (µm):

## Threading & Mounting

M72 x 0.75 (Female)	Filter Thread:
C-Mount	Mount:

## Regulatory Compliance

<a href="#">Compliant</a>	RoHS 2015:
<a href="#">Compliant</a>	REACH 201:
<a href="#">View</a>	Certificate of Conformance:

## Product Details

- High Resolution Telecentric Lens for Measurement and Gauging
- Up to 5 MegaPixels, 3.45µm Pixel Size Sensors
- Up to 2/3", C-Mount Telecentric Lens
- Magnification from 0.06X to 1X

TECHSPEC® GoldTL™ Telecentric Lenses were designed specifically for machine vision and metrology applications. The unique focusable design allows for working distance adjustment, while still providing <math><0.2^\circ</math> telecentricity. These lenses also feature high resolutions, low distortions, and are available for 1/2" or 2/3" sensors. TECHSPEC® GoldTL™ Telecentric Lenses have a front filter thread for easy integration of color filters, polarizers or other mounted components. Both the iris and focusing adjustment positions can be fixed by set screws to remain secure in high vibration environments.

## Technical Information

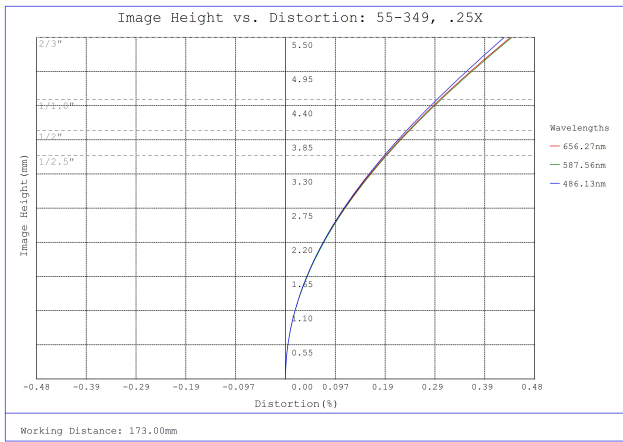

#55-349, 0.25X 2/3" GoldTL™ Telecentric Lens, Distortion Plot

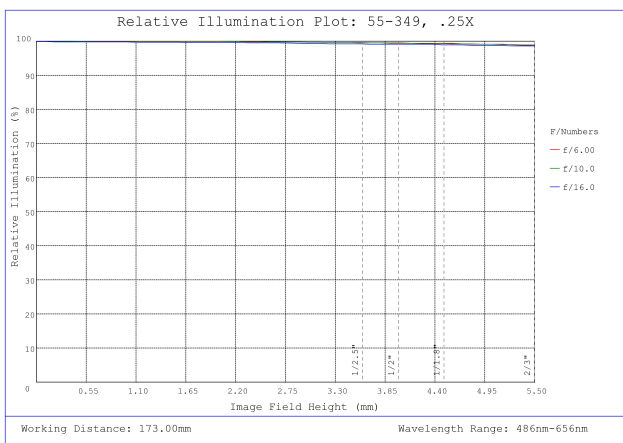

#55-349, 0.25X 2/3" GoldTL™ Telecentric Lens, Relative Illumination Plot

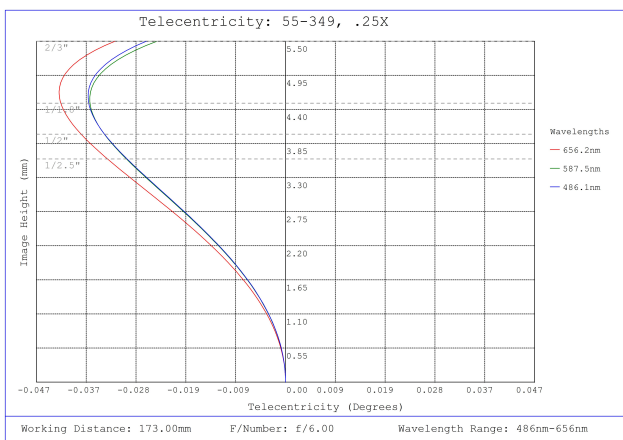

#55-349, 0.25X 2/3" GoldTL™ Telecentric Lens, Telecentricity Plot

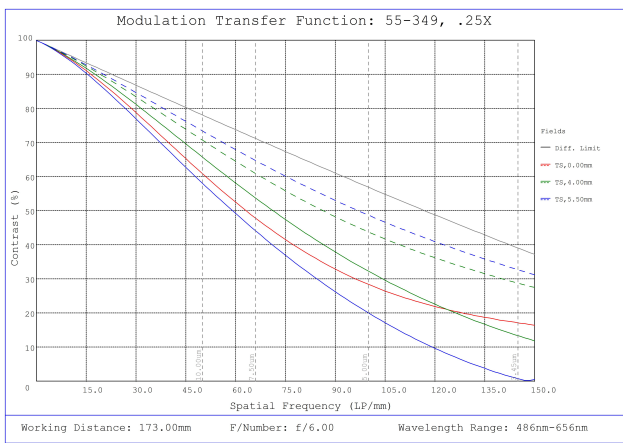

#55-349, 0.25X 2/3" GoldTL™ Telecentric Lens, Modulated Transfer Function (MTF) Plot, 173mm Working Distance, f6

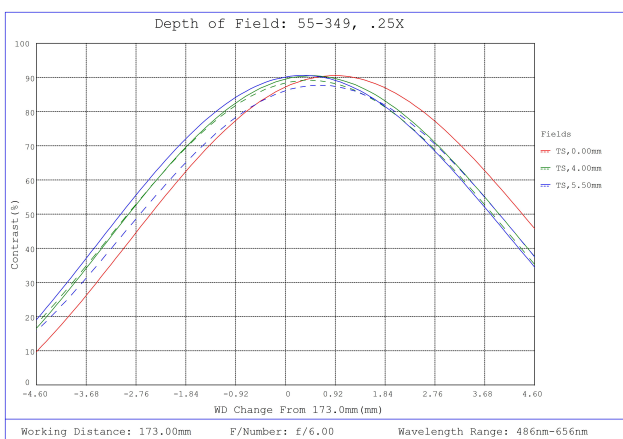

#55-349, 0.25X 2/3" GoldTL™ Telecentric Lens, Depth of Field Plot, 173mm Working Distance, f6

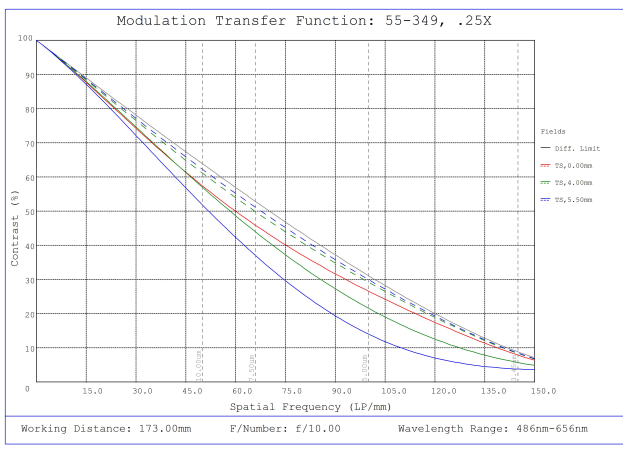

#55-349, 0.25X 2/3" GoldTL™ Telecentric Lens, Modulated Transfer Function (MTF) Plot, 173mm Working Distance, f10

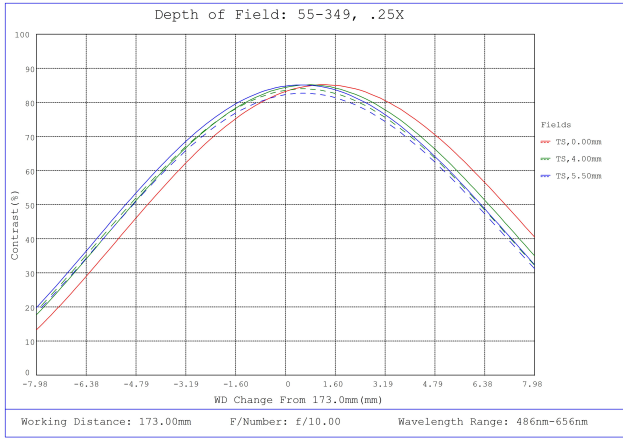

#55-349, 0.25X 2/3" GoldTL™ Telecentric Lens, Depth of Field Plot, 173mm Working Distance, f10

Stock No.	A	B	C	D	E	F	G
#56-024	88mm	16mm	34mm	94mm	120mm	101.6mm	50mm
#56-025	85mm	17.5mm	32.5mm	91mm	120mm	101.6mm	48.5mm
#56-026	103mm	—	39.5mm	107mm	103mm	90mm	55.5mm
#56-027	134mm	—	55mm	148mm	134mm	122mm	81mm

**Telecentric Lens Mounts**

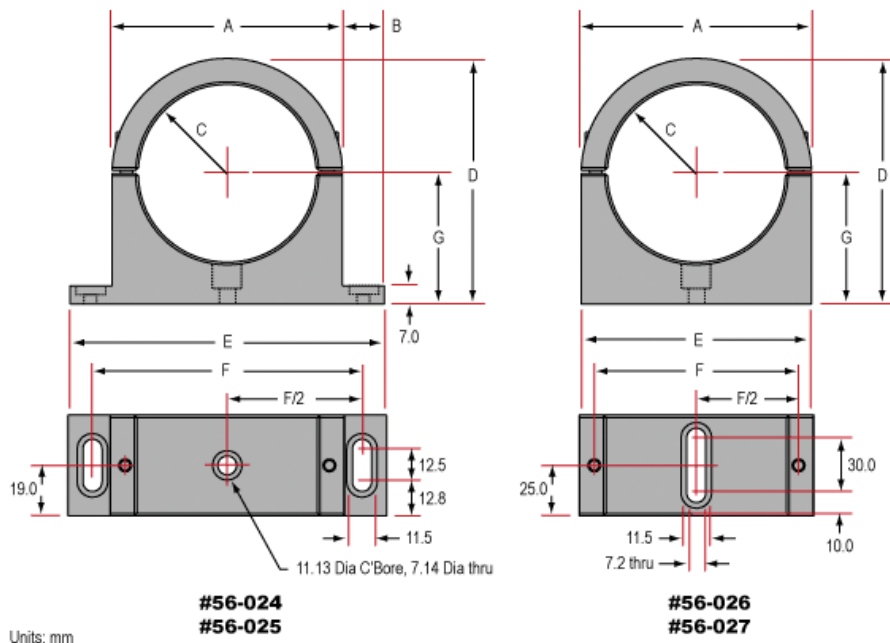

**Telecentric Lens Mount for #56-948**

