

317.5mm/12.5" Optic Dia., Optical Cell Kinematic Mount



Stock #36-480 **4 In Stock**

⊖ 1 ⊕ €5.480⁰⁰

ADD TO CART

Volume Pricing

Qty 1-4	€5.480,00 each
Qty 5-9	€4.833,00 each
Qty 10-25	€4.447,10 each
Need More?	Request Quote

ⓘ Prices shown are exclusive of VAT/local taxes

Product Downloads

General

Adjustable - Tip-Tilt **Type:**

Circular **Type of Optics:**

Range:

7°

Inner Diameter (inches):

12.56

Optic Holding Style:

Three Spring-Loaded Clips

Physical & Mechanical Properties

Clear Aperture CA (inches):

12.08

Clear Aperture CA (mm):

306.8

Optical Centerline (mm):

203.2

Dimensions (inches):

16.00 x 8.00 x 15.00

Dimensions (mm):

406.4 x 203.2 x 381.0

Weight (lbs):

41.0

Construction:

Black Anodized Aluminum, Stainless Steel

Diameter of Compatible Optics (inches):

12.50

Optical Centerline (inches):

8.00

Max. Thickness of Compatible Optics (mm):

53.0

Adjustment Screw Pitch (inches):

0.031

Threading & Mounting

Size of Compatible Optics (mm):

317.5

Regulatory Compliance

RoHS 2015:

[Compliant](#)

Certificate of Conformance:

[View](#)

Product Details

- Robust Kinematic Mounts for Larger Diameter Optics
- Ball Pivot and Fine Pitch Screws Provide Pitch and Roll
- 50% Greater Resolution than Micrometer Adjustments

Optical Cell Kinematic Mounts provide highly stable kinematic movement with two axis tilt (pitch and roll) provided by a precise ball pivot adjustment and an orthogonal three-point suspension. Adjustment is made by three 64-pitch screws (two 64-pitch screws for 1-2" diameter model). For the 6" diameter model, adjustment is made by two 64-pitch screws for and with three 32-pitch screws for 8" up to 12.5" diameter models. Optical Cell Kinematic Mounts feature fine pitch screws, which permit 50% greater resolution than a micrometer. An angled base on the mount allows for stand-alone installation and mounting. These mounts have integral optic cell design allowing optics to be held undistorted.

Note: For mounting 12" diameter optics in our 12.5" Diameter Optical Mount, use the 12.5" to 12" Adapter Kit (#12-226). The Adapter Kit and 12.5" Diameter Optical Mount are offered together as #12-227.

Technical Information

Optic Diameter	A	B	C	D	E	F	G	H	I	J	K	Stock No.
1-2"	2.25-20 TPI	3.75	2.00	2.00	0.38	2.00	3.50	0.28	-	2.12	-	#53-964
3"	3.25-20 TPI	5.75	3.00	4.00	1.25	3.38	6.25	0.28	-	5.00	-	#53-965
4.25"	4.625-20 TPI	5.75	3.00	4.00	1.25	3.38	6.25	0.28	-	5.00	-	#57-872

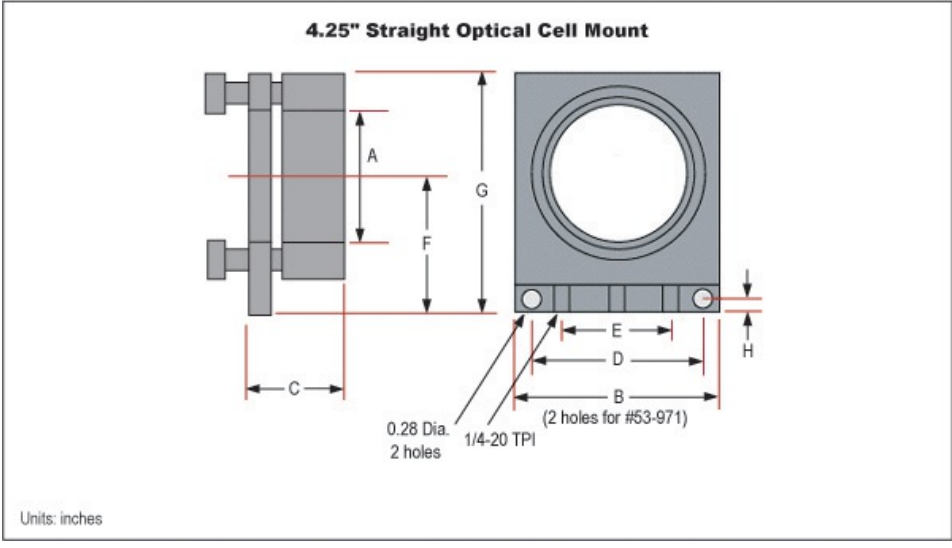
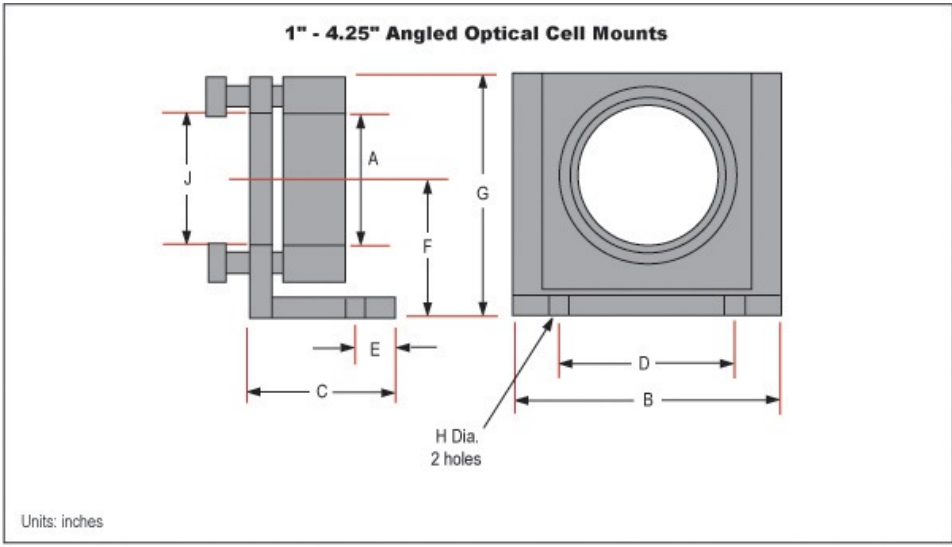

Optic Diameter	A	B	C	D	E	F	G	H	I	J	K	Stock No.
6"	6.187-32 TPI	8.00	6.00	5.00	5.00	4.50	8.00	0.28	5.75	6.00	1.19	#36-474
8"	8.06	12.00	7.00	10.00	6.00	6.25	11.50	0.28	7.62	9.00	1.60	#36-476
10"	10.06	16.00	8.00	12.00	6.00	8.00	15.00	0.53	9.58	12.50	1.75	#36-478
12.5"	12.56	16.00	8.00	12.00	6.00	8.00	15.00	0.53	12.08	12.50	2.13	#36-480

