

[See all 27 Products in Family](#)

12.7mm Clear Aperture 50R/50T, Pellicle Beamsplitter



Pellicle Beamsplitters

Stock #19-310 **1 In Stock**

⊖ 1 ⊕ €303.⁰⁰

ADD TO CART

Volume Pricing	
Qty 1-10	€303,00 each
Qty 11-25	€258,00 each
Qty 26+	€225,00 each
Need More?	Request Quote

ⓘ Prices shown are exclusive of VAT/local taxes

Product Downloads

General

Pellicle Beamsplitter **Type:**

Physical & Mechanical Properties

12.7 **Clear Aperture CA (mm):**

Construction:

Pellicle	
19.05	Diameter (mm):
Black Anodized Aluminum	Housing:
2 +0.3/-0.0	Thickness (µm):

Optical Properties

Dielectric	Coating:
50/50 @ 632.8nm	Coating Specification:
632.8	Design Wavelength DWL (nm):
1.5	Index of Refraction (n_d):
50/50 ±5%	Reflection/Transmission Ratio (R/T):
Nitrocellulose	Substrate: <input type="checkbox"/>
40-20	Surface Quality:

Threading & Mounting

3.18	Mount Thickness (mm):
2-56	Mounting Threads:

Regulatory Compliance

Compliant	RoHS 2015:
View	Certificate of Conformance:
Compliant	REACH 241:

Product Details

- No Ghost Images from Second Surface Reflections
- No Chromatic Aberration with Converging Beams
- No Change in Optical Path Length
- [Pellicle Beamsplitters for the Infrared \(IR\)](#) Also Available

Pellicle Beamsplitters are very thin nitrocellulose membranes bonded to lapped aluminum frames. They feature no ghost images from second surface reflections. To ease system integration, these beamsplitters offer mounting holes on the underside of the frame. Pellicle Beamsplitters are resistant to mechanical shock or climate variations but must be protected from dust and spray to avoid damage to the pellicle membrane. Please note, environments with a high level of humidity (>55%) can cause a temporary loss of tension in the pellicle membrane. The membrane will revert to normal tension if humidity is lowered.

Note: Extra care must be taken when handling.

Technical Information

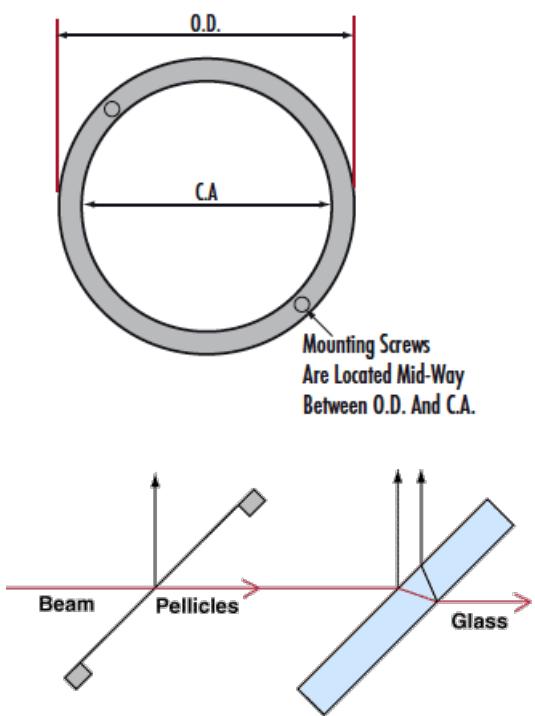

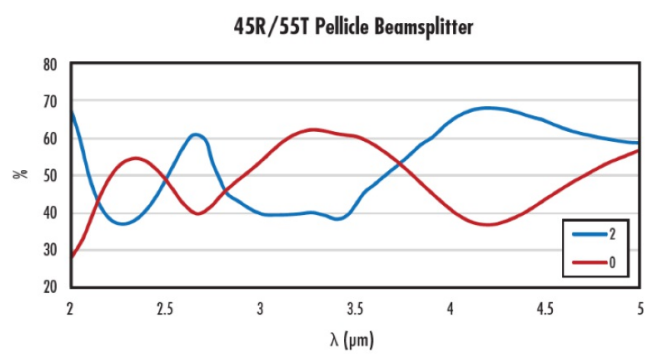
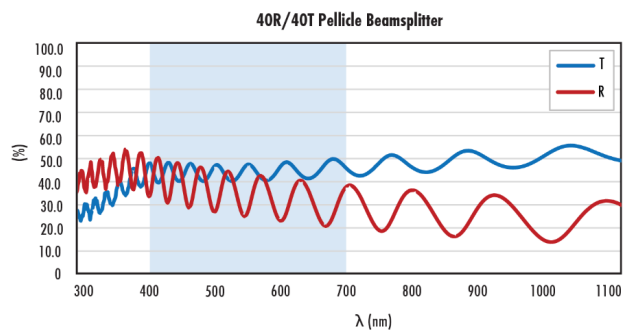
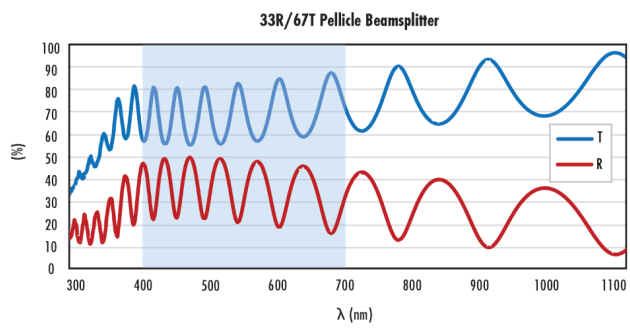
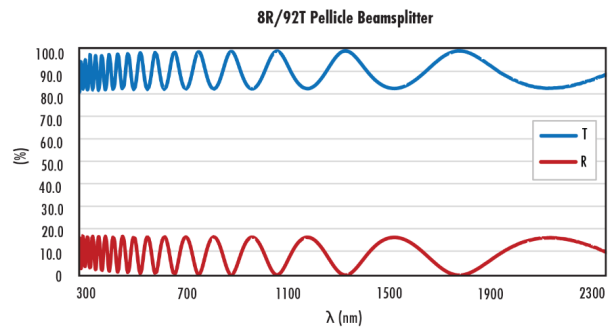
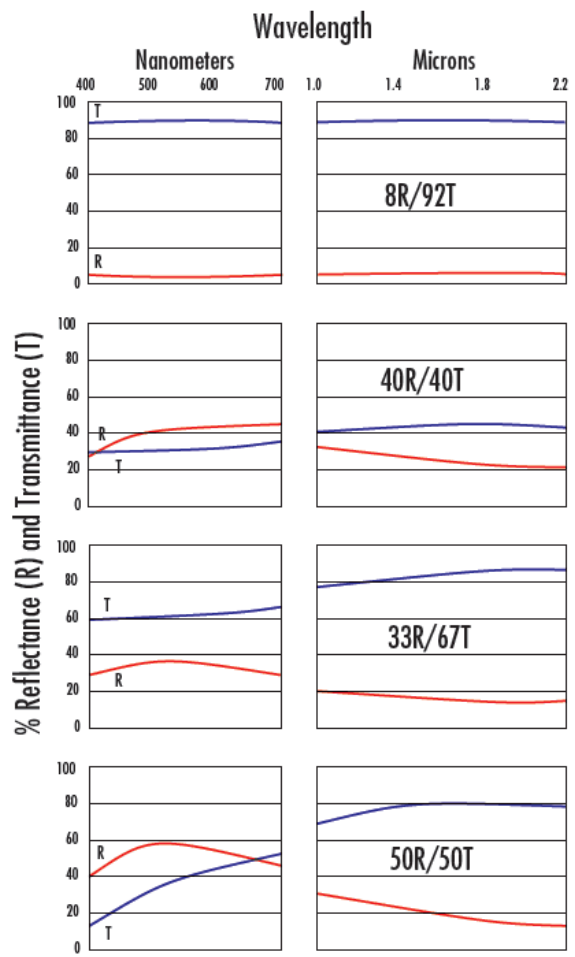
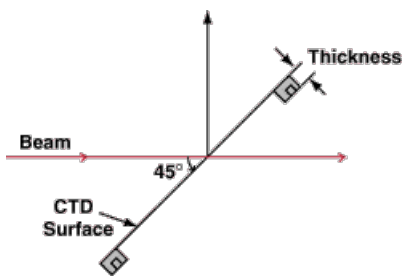

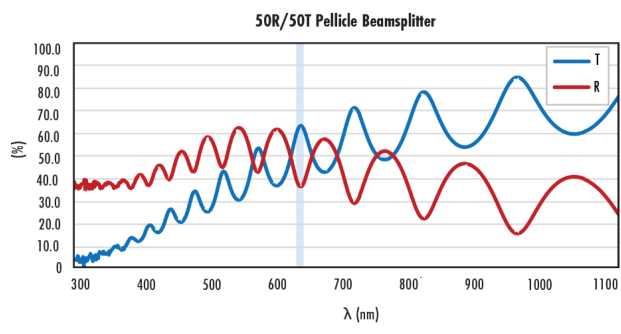

Special Handling

These optics require special handling to avoid damage and ensure long-term performance. Proper handling, cleaning, and storage are essential to maintain optical quality. Explore our [Optics Cleaning Resources](#) for step-by-step guides and best practices. For personalized assistance, [Email us](#) or [Chat](#) with our technical support team.



Component Handling Tools

Compatible Mounts

;