

[See all 20 Products in Family](#)

12.7mm Optic Dia., Optic Mount



Optic Component Mounts

Stock #64-556 **14 In Stock**

⊖ 1 ⊕ €32⁷⁵

ADD TO CART

Volume Pricing	
Qty 1-9	€32,75 each
Qty 10+	€29,60 each
Need More?	Request Quote

ⓘ Prices shown are exclusive of VAT/local taxes

Product Downloads

General

Fixed **Type:**
Circular **Type of Optics:**

Physical & Mechanical Properties

9.5 **Clear Aperture CA (mm):**

35.0	Outer Diameter (mm):
16.00	Thickness (mm):
Black Anodized Aluminum	Construction:
10.00	Max. Thickness of Compatible Optics (mm):

Threading & Mounting

12.7	Size of Compatible Optics (mm):
M6 x 1.0, 1/4-20	Compatible Post:

Regulatory Compliance

Compliant	RoHS 2015:
View	Certificate of Conformance:
Compliant	Reach 247:

Product Details

- Simple Mounting Arrangement
- Metric and English Configurations
- Black Anodized Aluminum Construction
- [Posts](#) and [Post Holders](#) Required for Mounting

Optic Component Mounts are designed to hold lenses, filters, mirrors, and other optical components. The included retainer ring securely holds the component in place. Optic Component Mounts need the required [posts](#) and [post holders](#) for mounting to a breadboard. Both English (1/4-20) and Metric (M6) standard posts are accepted by the mounts. These mounts are constructed of black anodized aluminum in a simple mounting arrangement.

Technical Information

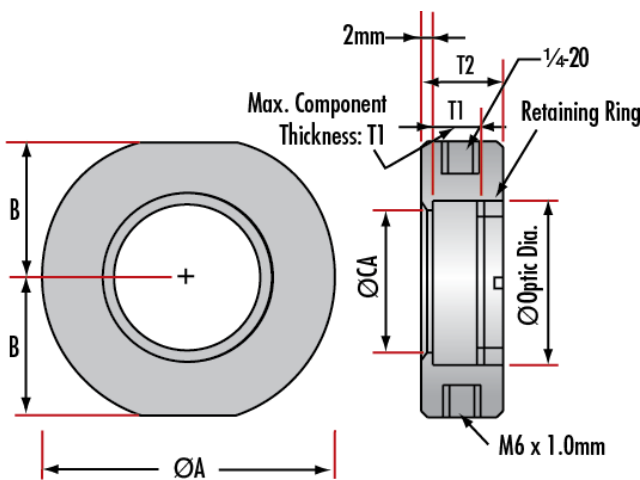

Maximum Optic Diameter	Clear Aperture (CA)	Mount Diameter A	B	Maximum Optic Thickness T1	Mount Thickness T2	Stock No.
5	4	30	13.5	5.7	12	#64-551
6	5	30	13.5	5.7	12	#64-552
9	6	30	13.5	6	12	#64-553
10	7	30	13.5	6	12	#64-554
12	9	35	16.0	10	16	#64-555
12.7	9.5	35	16.0	10	16	#64-556
15	12	35	16.0	10	16	#64-557
18	15	40	19.0	12	18	#64-558
20	17	40	19.0	12	18	#64-559
25	22	45	21.5	10	16	#64-560
25.4	22	45	21.5	10	16	#64-561
25.4	22	45	21.5	13	19	#65-562
30	26	50	24.0	6	12	#64-563
30	26	50	24.0	12	18	#64-564
38.1	34	60	29.0	12	18	#64-565
40	36	60	29.0	12	18	#64-566
50	46	70	34.0	12	18	#64-567
50	46	70	34.0	18	24	#64-568
50.8	46	70	34.0	12	28	#64-569

