

## 1X 120mm WD, In-Line Illumination Telecentric Lens



Stock #59-741 **1 In Stock**

⊖ 1 ⊕ €1.679<sup>00</sup>

**ADD TO CART**

### Volume Pricing

Qty 1+	€1.679,00 each
Need More?	<a href="#">Request Quote</a>

ⓘ Prices shown are exclusive of VAT/local taxes

### Product Downloads

### General

**Product Family:**  
In-Line Illumination C-Mount Telecentric Lenses

**Type:**  
Telecentric Lens

**Compatible Light Guide/Source:**  
1/4" (0.312")

**Type of Illumination:**  
In-Line Illumination

### Physical & Mechanical Properties

137.00	Length (mm):
0.312	Ferrule Diameter (inches):
29.5	Maximum Diameter (mm):

## Optical Properties

8.8mm	Horizontal Field of View @ Max Sensor Format:
8.8mm	Horizontal Field of View, 2/3" Sensor:
6.4mm	Horizontal Field of View, 1/2" Sensor:
11.00	Maximum Image Circle (mm):
1X	Primary Magnification PMAG:
1.00	Telecentric Lens Magnification:
120.00	Working Distance (mm):
f/16.6	Aperture (f/#):
≤0.1	Distortion (%):
1X	Magnification:
VIS	Lens Wavelength Range:

## Sensor

2/3"	Maximum Sensor Format:
4.20	Pixel Size (µm):

## Threading & Mounting

N/A	Filter Thread:
C-Mount	Mount:

## Regulatory Compliance

<a href="#">View</a>	Certificate of Conformance:
----------------------	-----------------------------

## Product Details

- Fiber Optic Input for In-line Illumination
- Long Working Distance
- 2/3" Max Sensor Format

This compact series of telecentric lenses offers a versatile solution for many applications. The compact size and long working distance are necessary for some environments. Each lens offers an in-line illumination port that accepts a 1/4" fiber optic light guide. In-line illumination is convenient for situations in which there is no room for light sources between the lens and the object under test. Although contrast may decrease compared to other lighting techniques, the 1X through 6X lenses offer extremely even in-line illumination over a 10mm horizontal sensor size. These lenses offer the same measuring advantages as our other telecentric lenses. They correct perspective errors throughout the depth of field to avoid changes in magnification. This correction is vital to the majority of automated measurement applications. M3 set screws are incorporated in the in-line illumination port to secure the light guide. Each lens also includes a lockable ring to rotate the lens and ensure alignment with the camera sensor.

**Note:** 1/4" [Fiber optic light guides](#) are sold separately.

## Technical Information

Magnification	A	B	C	D
0.5X	170mm	25mm	113mm	40mm
0.75X	160mm	42mm	86mm	29.5mm
1X	137mm	34mm	71mm	29.5mm
2X	110mm	33mm	45mm	17mm
3X	100mm	23mm	45mm	17mm
4X	110mm	33mm	45mm	17mm
5X	115mm	38mm	45mm	17mm

6X

120mm

43mm

45mm

17mm

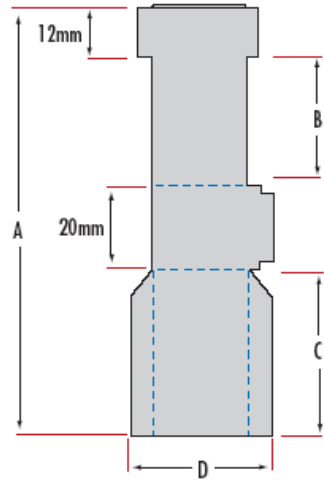

;