

[See all 49 Products in Family](#)

TECHSPEC® 25mm f/11, UCi Series Fixed Focal Length Lens



25mm UCi Series Fixed Focal Length Lens



Stock #33-895 **4 In Stock**

⊖ 1 ⊕ €235⁰⁰

ADD TO CART

Volume Pricing

Qty 1+	€235,00 each
Need More?	Request Quote

ⓘ Prices shown are exclusive of VAT/local taxes

Product Downloads

General

UCi Series **Product Family:**

Fixed Focal Length Lens **Type:**

No **IR Cut Filter:**

Physical & Mechanical Properties

Fixed	Iris Option:
31.50	Length (mm):
26.5	Maximum Diameter (mm):
26.5	Outer Diameter (mm):
38	Weight (g):
2.54	Maximum Rear Protrusion (mm):

Optical Properties

Horizontal Field of View @ Max Sensor Format:
60.8mm - 16.4°

Field of View at Max Sensor Format:
Horizontal: 59.6mm - 16.4°
Vertical: 44.6mm - 12.3°
Diagonal: 74.7mm - 20.4°

Horizontal Field of View, 1/1.8" Sensor:
60.8mm - 16.4°

Horizontal Field of View, 1/2" Sensor:
54.0mm - 14.6°

Horizontal Field of View, 1/2.5" Sensor:
48.9mm - 13.2°

Horizontal Field of View, 1/3" Sensor:
40.4mm - 11.0°

Horizontal Field of View, 1/4" Sensor:
30.3mm - 8.2°

Maximum Image Circle (mm):
9.00

Numerical Aperture NA, Object Side:
0.0052

Number of Elements (Groups):
7 (5)

Focal Length FL (mm):
25.00

Working Distance (mm):
200 - ∞

Aperture (f/#):
f/11.0

Coating:
M4 MgF₂

Coating Specification:
M4 MgF₂

Entrance Pupil Position (mm):
15.05

Object Space Principal Plane (mm):
29.11

Image Space Principal Plane (mm):
-12.34

Maximum Distortion (%):
-0.15

Exit Pupil Position (mm):
-44.48

Lens Wavelength Range:
VIS

Sensor

Optimized Sensor Format:
1/2.5"

Maximum Sensor Format:
1/1.8"

Pixel Size (μm):
1.85

Threading & Mounting

Filter Thread:
N/A

Mount:
C-Mount

Environmental & Durability Factors

Storage Temperature (°C):

-20 to +60

Type of Ruggedization:

Industrial (Fixed Aperture with Simplified Mechanics)

Regulatory Compliance

Certificate of Conformance:

[View](#)

Product Details

- Up to 1/1.8", C-Mount, S-Mount Lens
- Up to 12 MegaPixels, 1.85µm Pixel Size Sensors
- Instrumentation (UCi) versions of our UC Series Lenses with Streamlined Mechanical Designs and Fixed Apertures
- 4mm to 35mm Focal Length

TECHSPEC® UCi Series Fixed Focal Length Lenses utilize the same optics as the TECHSPEC UC Series Lenses and feature 4K resolution. These lenses are designed for small pixels $\leq 2.2\mu\text{m}$ and offer a wide range of fixed apertures for a variety of applications. While optimized for 1/2.5" sensors, many focal length options can be used on sensors up to 1/1.8". TECHSPEC® UCi Series Fixed Focal Length Lenses are ideal for OEM applications that require small, robust, and lightweight imaging solutions.

Note: For adjustable aperture options, see our [TECHSPEC® UC Series Fixed Focal Length Lenses](#).

Edmund Optics has created a family of high-performance ultra-compact optical designs (the UC Series family) and developed 3 customized optomechanical solutions targeted for specific applications. These lens sub-families utilize the same optics as the UC Series lenses providing the same optical performance in a variety of optomechanical solutions to meet your application requirements:

UC Series: Features locking cam focus and iris adjustment in an ultra-compact design and is the most adjustable version of these optical designs; they are the typical high-quality machine vision lenses.

UCi Series: Simplified mechanics featuring fixed apertures with compact housing. [Industrial Ruggedization](#) for reduced size, cost, and locked focus.

UCr Series: All optics glued in place and a locking C-clamp focus ring. [Stabilized Ruggedization](#) for reduced pixel shift and improved focus stability.

UCw Series: Waterproof, designed to meet IEC [Ingress Protection](#) Code IPX7 to withstand exposure to water up to 1 meter depth for 30 minutes.

Technical Information

4mm Focal Length

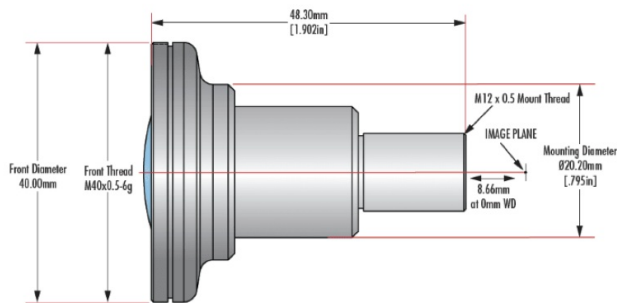

6mm Focal Length

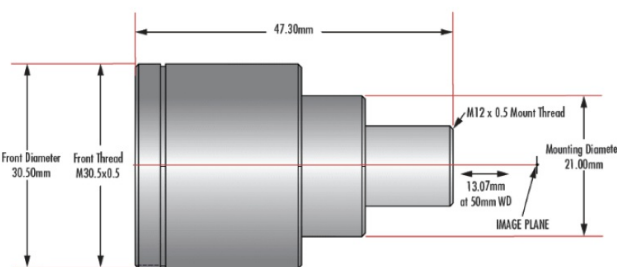

12mm Focal Length

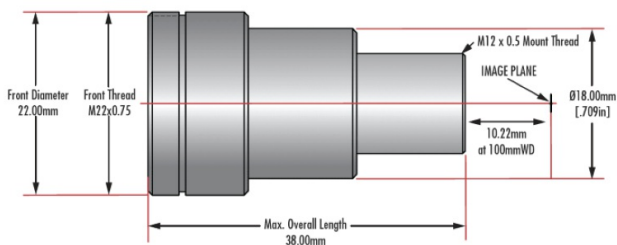

16mm Focal Length



25mm Focal Length



35mm Focal Length



Compatible Cameras