

[See all 23 Products in Family](#)

25mm Travel, Motorized Linear Stage, Integrated Controller, Rotary Encoder

See More by [Zaber™](#)



#15-285, 25 mm Travel, Motorized Linear Stage, Integrated Controller

Stock **#22-217** **2 In Stock**

⊖ 1 ⊕ €2.465⁰⁰

ADD TO CART

Volume Pricing	
Qty 1+	€2.465,00 each
Need More?	Request Quote

ⓘ Prices shown are exclusive of VAT/local taxes

Product Downloads

General

Metric **Type:**

Yes **Encoder:**

Yes **Manual Control/ LED Indicators:**

Zaber Technologies Inc. **Manufacturer:**

Note:
Requires a 24-48 VDC power supply and either [#15-295](#) for USB connectivity or [#15-297](#) for RS-232 connectivity. A data cable ([#15-296](#) or [#15-299](#)) can be used to daisy chain multiple stages together to control simultaneously.

Type of Motor:
2-Phase Stepper

Encoder Type:
Rotary Quadrature Encoder

Physical & Mechanical Properties

Type of Movement:
Linear (X)

Guide System:
Needle Roller Bearing

Stage Size (mm):
45 x 162.6

Travel (mm):
25.4

Accuracy (µm):
15 (Unidirectional)

Backlash (µm):
<12

Height (mm):
21

Load Capacity (kg):
10

Parallelism (µm):
<25

Repeatability (µm):
<3

Speed (mm/s):
0.00003 to 26

Weight (kg):
0.35

Encoder Resolution:
200 CPR

Total Track (mm):
75.80

Optical Properties

Resolution (µm):
0.05

Electrical

Maximum Operating Current (mA):
350

Hardware & Interface Connectivity

Type of Drive:
Precision Lead Screw

Power Supply:
Power Supply Required and Sold Separately.
USA: [#15-294](#)
Europe: [#15-294](#)
Japan: [#23-662](#)
Korea: [#33-773](#)
China: [#15-294](#)

Computer Interface:
USB with [#15-295](#)
RS-232 with [#15-297](#)

Environmental & Durability Factors

Operating Temperature (°C):
0 - 50

Regulatory Compliance

RoHS 2015:
[Compliant](#)

Certificate of Conformance:
[View](#)

Reach 247:
[Compliant](#)

Product Details

- High Accuracy, 25mm, 50mm, 100mm, and 200mm Travel Options
- Integrated Motor and Controller
- Available with Integrated, 200 Counts per Revolution (CPR) Motor Mounted Encoder
- Easily Configurable in X-Y or X-Y-Z Configurations
- Vacuum-Compatible Options

Zaber™ High Precision Motorized Stage Systems are computer-controlled, self-contained linear stages that include a stepper motor and built-in controller. Zaber™ High Precision Motorized Stage Systems can connect directly to a computer's RS-232 port, while the included software provides an easy method for controlling travel distance or position. Additionally, the manual control potentiometer permits smooth manual movement. Encoder versions are available for all travel lengths, with 200 Counts per Revolution (CPR) rotary quadrature encoders integrated into the stepper motor. The integrated rotary encoder provides closed-loop control and slip/stall detection and recovery.

Note: A bottom adapter plate (sold separately) is required for mounting to a standard metric or English breadboard. A 24-48 VDC universal power supply, data cables for daisy chaining, and computer interface cables (USB or RS-232) are sold separately as accessories. Use Top Adapter Plate #68-644 to Mount 70mm TECHSPEC® Stages.

Technical Information

Device Overview / Connectors

Images are shown looking into the device.

Power

Pin	Description
1	24 - 48 V
2	GND (Note: power supplies ground this pin to AC Earth)

Note: To prevent damage to the device due to static buildup, the device should be properly grounded. The power supplies for X-Series devices are non-isolated and thus ground the device chassis to Earth via the negative terminal of the power supply. If for any reason you are using an isolated power supply, please ensure your device is grounded by connecting the negative terminal of the power connector to AC Earth.

#68-645

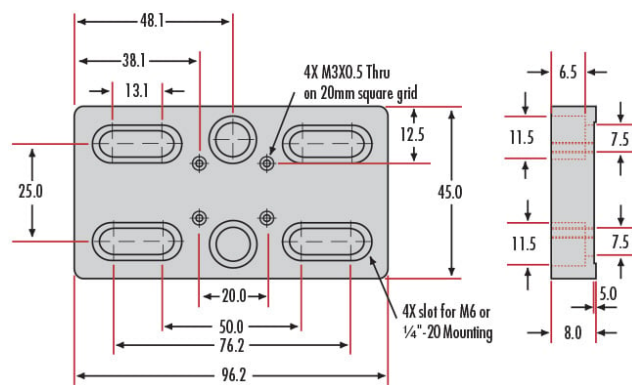

#68-644

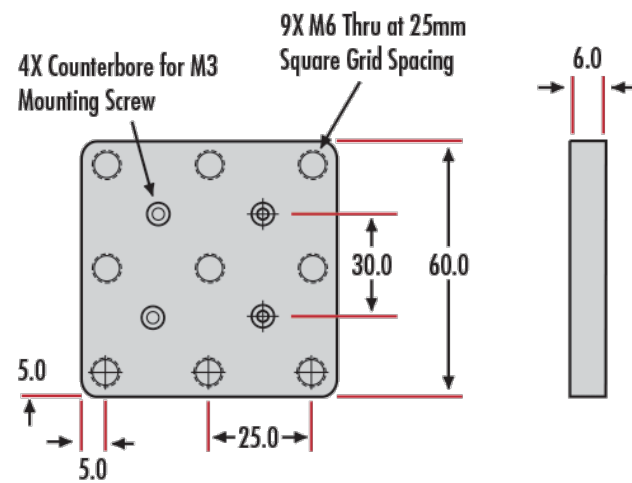

#68-343

