

[See all 97 Products in Family](#)

TECHSPEC® 3mm FL f/4.0, IR-Cut Blue Series M12 Lens



3mm FL Blue Series M12 Lens



Stock #20-056 **20+ In Stock**

⊖ 1 ⊕ €81⁰⁰

ADD TO CART

Volume Pricing	
Qty 1-49	€81,00 each
Qty 50+	€64,00 each
Need More?	Request Quote

ⓘ Prices shown are exclusive of VAT/local taxes

Product Downloads

General

Blue Series **Product Family:**

M12 Imaging Lens **Type:**

IR Cut Filter:

Yes

Imaging Lens Type:
High Performance M12 Lens with IR Cut Filter

Special Type of Lens:
IR-Cut Filter

Physical & Mechanical Properties

Iris Option:
Fixed

Length (mm):
16.10

Maximum Diameter (mm):
14

Outer Diameter (mm):
14

Optical Properties

Horizontal Field of View @ Max Sensor Format:
91.3°

Field of View at Max Sensor Format:
Horizontal: 91.2°
Vertical: 68.5°
Diagonal: 113°

Horizontal Field of View, 1/3" Sensor:
91.2°

Maximum Image Circle (mm):
6.00

Numerical Aperture NA, Object Side:
0.004

Number of Elements (Groups):
6(5)

Wavelength Range (nm):
400 - 700

Focal Length FL (mm):
3.00

Working Distance (mm):
100 - ∞

Aperture (f/#):
f/4

Distortion (%):
-34.8 @ Full Field

Back Focal Length BFL (mm):
4.8 - 4.7

Coating Specification:
λ/4 MgF₂ @ 550nm

Entrance Pupil Position (mm):
4.90

Object Space Principal Plane (mm):
-6.55

Image Space Principal Plane (mm):
2.46

Maximum Distortion (%):
-34.8

Exit Pupil Position (mm):
-3.23

Lens Wavelength Range:
VIS (IR-Cut Filter)

Sensor

Maximum Sensor Format:
1/3"

Pixel Size (μm):
1.40

Threading & Mounting

Filter Thread:
N/A

Mount:
S-Mount (M12 x 0.5)

Regulatory Compliance

RoHS 2015:
[Compliant](#)

Certificate of Conformance:
[View](#)

Product Details

- Up to 1/2", S-Mount Lens
- Up to 5 MegaPixels, 1.4µm Pixel Size Sensors
- High Resolution Board Camera Lens Optimized for Close WD
- 2mm to 35mm Focal Length
- **Ruggedized Designs** Also Available

TECHSPEC® Blue Series M12 Lenses feature high resolution performance, along with the same great versatility of our **TECHSPEC® Green Series M12 Lenses**. Each lens consists of several precision glass elements mounted in a compact, aluminum housing. These lenses can connect to C-Mount cameras using the M12 x0.5 Adapter for C-Mount Cameras (**#53-675**) or the M12 x0.5 C-Mount Adapter with Rubber O-Ring (**#59-241**) for vibration-sensitive environments. TECHSPEC® Blue Series M12 Lenses are ideal for automotive, industrial, and medical imaging application. Prescription data is available by submitting a **Request for Prescription Form**.

Note: Compatible **TECHSPEC® M12 Imaging Lens Accessories** available.

Edmund Optics has created multiple product families of our TECHSPEC® M12 S-Mount Lenses, which are designed to provide high resolution. These high performance lenses feature precision glass designs in a metal housing and have optimized specifications between each product family to meet your application needs.

- **Blue Series M12 Lenses:** High resolution finite conjugate designs optimized for machine vision working distances.
- **Rugged Blue Series M12 Lenses:** **Stabilized ruggedization** versions of our Blue Series M12 Lenses, utilizing the same optics.
- **Green Series M12 Lenses:** Finite conjugate designs optimized for machine vision working distances.
- **Red Series M12 Lenses:** Infinite conjugate designs optimized for high resolution performance out to infinity.
- **HEO Series M12 Lenses:** Harsh Environment Optics (HEO) sealed versions of our Red Series M12 Lenses.
- **Liquid Lens M12 Lenses:** Integrated liquid lens for fast electronic focus.

Technical Information

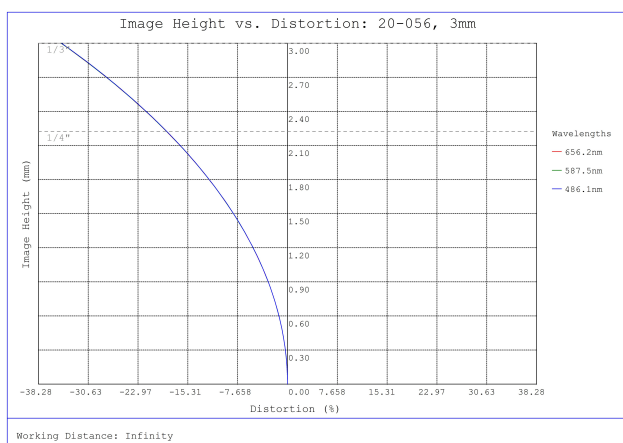

#20-056, 3mm FL f/4.0, IR-Cut Blue Series M12 Lens, Distortion Plot

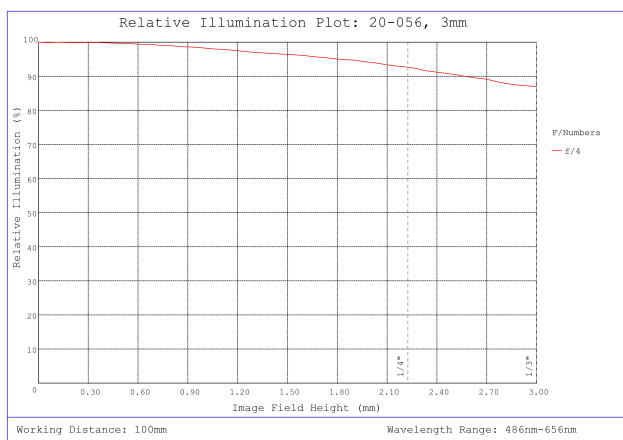

#20-056, 3mm FL f/4.0, IR-Cut Blue Series M12 Lens, Relative Illumination Plot

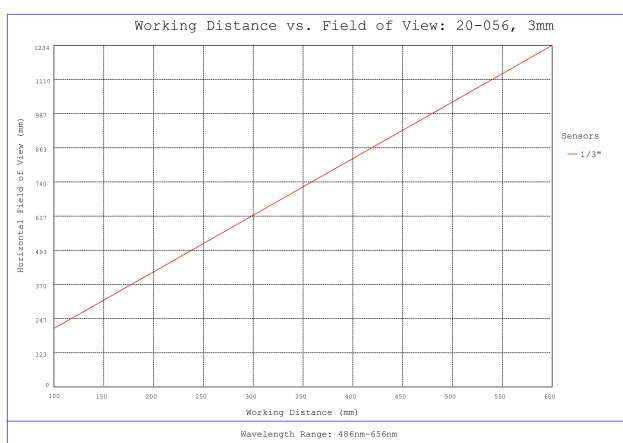

#20-056, 3mm FL f/4.0, IR-Cut Blue Series M12 Lens, Working Distance versus Field of View Plot

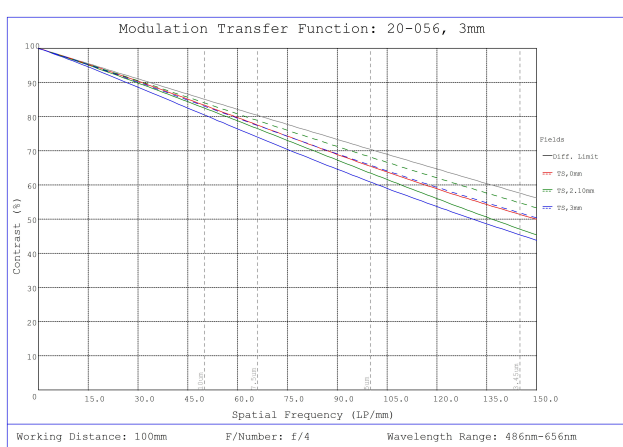

#20-056, 3mm FL f/4.0, IR-Cut Blue Series M12 Lens, Modulated Transfer Function (MTF) Plot, 100mm Working Distance, f4

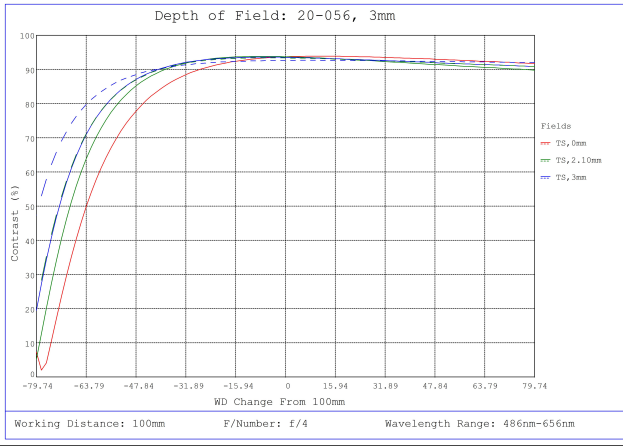

#20-056, 3mm FL f/4.0, IR-Cut Blue Series M12 Lens, Depth of Field Plot, 100mm Working Distance, f4

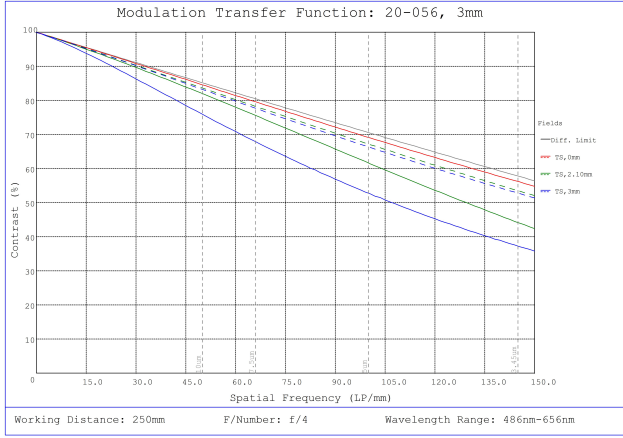

#20-056, 3mm FL f/4.0, IR-Cut Blue Series M12 Lens, Modulated Transfer Function (MTF) Plot, 250mm Working Distance, f4

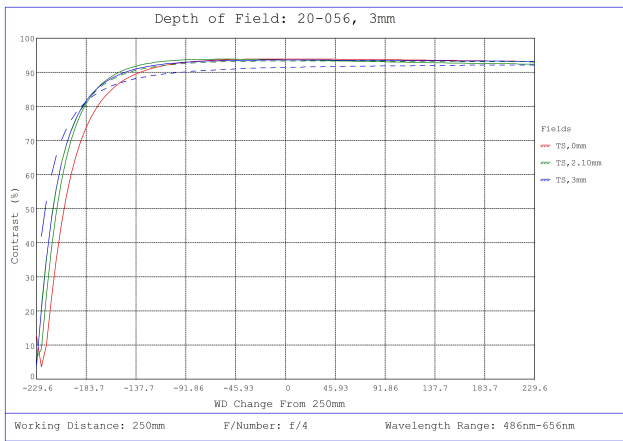

#20-056, 3mm FL f/4.0, IR-Cut Blue Series M12 Lens, Depth of Field Plot, 250mm Working Distance, f4

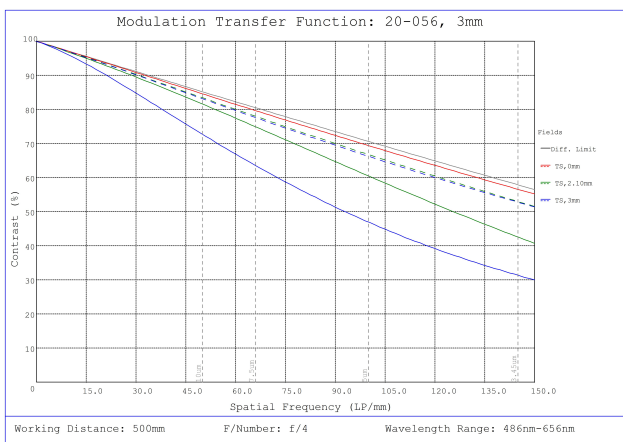

#20-056, 3mm FL f/4.0, IR-Cut Blue Series M12 Lens, Modulated Transfer Function (MTF) Plot, 500mm Working Distance, f4

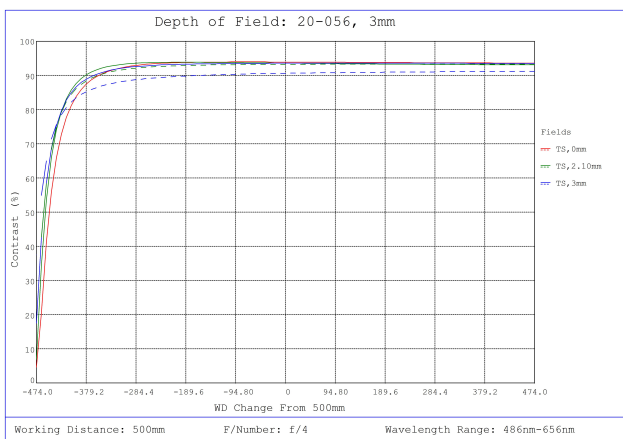

#20-056, 3mm FL f/4.0, IR-Cut Blue Series M12 Lens, Depth of Field Plot, 500mm Working Distance, f4

Focal Length	A	B	C*	D
2.0mm	18.0mm	21.7mm	2.26mm	4.75mm

3.0mm	14.0mm	17.1mm	4.8 - 4.7mm	5.8mm
4.0mm	14.0mm	19.7mm	6.1 - 6.0mm	4.4mm
5.0mm	14.0mm	14.6mm	4.0 - 3.9mm	3.7mm
6.0mm	14.0mm	14.1mm	6.9 - 6.8mm	4.5mm
8.0mm	14.0mm	12.3mm	8.8 - 8.6mm	3.7mm
10.0mm	14.0mm	17.0mm	6.6 - 6.3mm	3.7mm
12.5mm	15.0mm	22.9mm	10.1 - 9.7mm	4.8mm
17.5mm	14.0mm	20.7mm	5.8 - 4.9mm	7.6mm
25.0mm	18.0mm	30.0mm	8.5 - 6.5mm	11.5mm
35.0mm	18.0mm	29.5mm	18.72 - 14.0mm	14.5mm

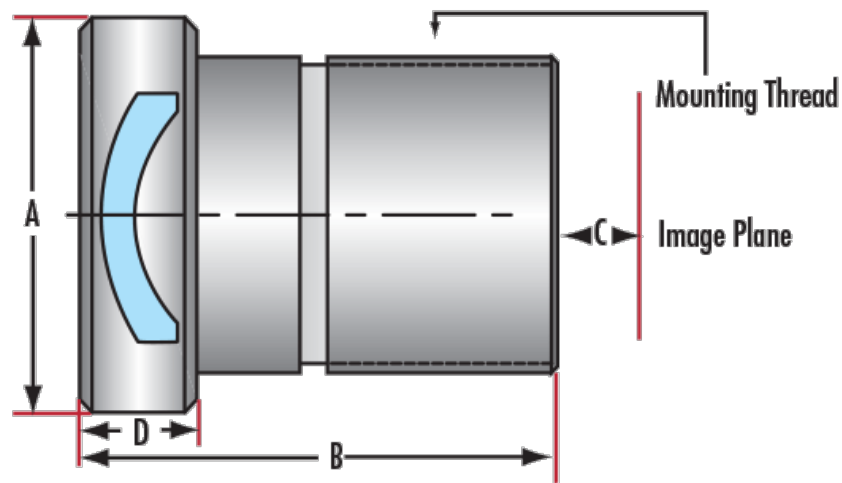

*Specified for Optimized Working Distance of 150 - 250mm.