

40X ZEISS EC Epiplan Objective

See More by [ZEISS](#)



ZEISS EC Epiplan Objectives



Stock #13-825 **5 In Stock**

⊖ 1 ⊕ €1.634⁰⁰

ADD TO CART

Volume Pricing	
Qty 1+	€1.634,00 each
Need More?	Request Quote

ⓘ Prices shown are exclusive of VAT/local taxes

Product Downloads

General

Model Number:
422060-9901-000

Compatible Tube Lens Focal Length (mm):
Focal Length: 164.50mm

Type:
Microscope Objective

Typical Applications:
Fluorescence, BrightField, Differential Interference Contrast, Reflected Light DIC, DIC with circular polarized light, total interference contrast

Style:
Infinity Corrected

Manufacturer:
Zeiss

Physical & Mechanical Properties

Field of View (mm):
0.575

Length excluding Threads (mm):
42.80

Maximum Diameter (mm):
30

Weight (g):
180

Optical Properties

Compatible Cover Glass Thickness (mm):
N/A

Focal Length FL (mm):
4.10

Magnification:
40X

Numerical Aperture NA:
0.60

Resolving Power (μm):
0.46

Depth of Field (μm):
0.76

Working Distance (mm):
2.2

Wavelength Range (nm):
480 - 650

Field Number (mm):
23

Parfocal Length (mm):
45

Immersion Liquid:
N/A

Threading & Mounting

Mounting Threads:
M27 x 0.75

Environmental & Durability Factors

Operating Temperature ($^{\circ}\text{C}$):
+10 to +40

Operating Humidity:
75% at 35 $^{\circ}\text{C}$

Regulatory Compliance

Certificate of Conformance:
[View](#)

Product Details

- Ideal for Brightfield, Fluorescence, and Differential Interference Contrast Applications
- Enhanced Contrast
- Excellent Color Correction and Flatness of Field

ZEISS EC Epiplan Infinity Corrected Objectives are plan achromats and feature excellent color correction and flatness of field. Designed to meet the requirements of ISO 19012-1:2013, these objectives are ideal for material microscopy applications. By minimizing stray light, these objectives enhance system contrast making them ideal for reflected light brightfield applications. ZEISS EC Epiplan Infinity Corrected Objectives have a 23mm field number enabling large areas of magnification.

Note: Tube Lens [#13-828](#) is required when using ZEISS EC Epiplan Infinity Corrected Objectives with non-ZEISS Infinity Color Corrected (ICS) microscope systems.

Technical Information

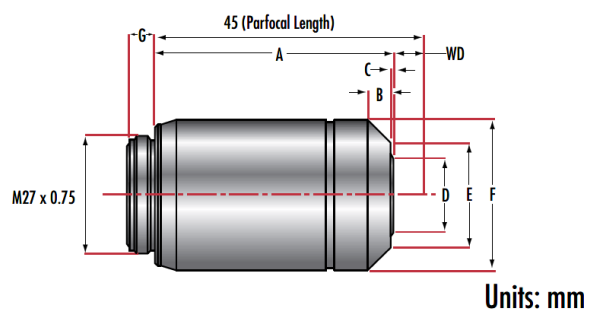

Stock No.	EC Epiplan	A	B	C	D	E	F	G	W.D.	PFL	Mounting Threads
#13-822	5X	33.20	2.10	6.00	11.6	22.5	30.0	3.9	11.80	45.00	M27x0.75
#13-823	10X	34.00	2.10	6.80	11.6	22.5	30.0	3.9	11.00	45.00	M27x0.75
#13-824	20X	41.80	7.40	3.80	12.6	22.5	30.0	3.9	3.20	45.00	M27x0.75
#13-825	40X	42.80	9.40	2.80	9.1	14.5	30.0	3.9	2.20	45.00	M27x0.75
#13-826	50X	44.05	8.10	5.35	9.0	22.5	30.0	3.9	1.00	45.00	M27x0.75
#13-827	100X	44.15	8.10	5.45	9.0	22.5	30.0	3.9	0.87	45.00	M27x0.75