

**TECHSPEC® 4mm FL f/4.0, Blue Series M12 Lens**



4mm FL Blue Series M12 Lens



Stock **#89-345** **13 In Stock**

⊖ 1 ⊕ €81<sup>00</sup>

**ADD TO CART**

Volume Pricing	
Qty 1-49	€81,00 each
Qty 50+	€64,00 each
Need More?	<a href="#">Request Quote</a>

ⓘ Prices shown are exclusive of VAT/local taxes

Product Downloads

**SPECIFICATIONS**

**General**

Series:

Blue Series

M12 Imaging Lens **Type:**

No **IR Cut Filter:**

High Performance M12 Lens **Imaging Lens Type:**

## Physical & Mechanical Properties

Fixed **Iris Option:**

19.70 **Length (mm):**

14 **Maximum Diameter (mm):**

14 **Outer Diameter (mm):**

6 **Weight (g):**

## Optical Properties

**Horizontal Field of View @ Max Sensor Format:**  
71.1°

**Field of View at Max Sensor Format:**  
Horizontal: 220mm - 71.1°  
Vertical: 152.6mm - 52.6°  
Diagonal: 310.8mm - 90.8°

**Horizontal Field of View, 1/3" Sensor:**  
219.4mm - 71.0°

**Horizontal Field of View, 1/4" Sensor:**  
152.3mm - 52.5°

6.00 **Maximum Image Circle (mm):**

0.0032 **Numerical Aperture NA, Object Side:**

6(5) **Number of Elements (Groups):**

400 - 700 **Wavelength Range (nm):**

4.00 **Focal Length FL (mm):**

150 - ∞ **Working Distance (mm):**

f/4 **Aperture (f#):**

-25.68 @Full Field **Distortion (%):**

6.1 - 6.0 **Back Focal Length BFL (mm):**

λ/4 MgF<sub>2</sub> @ 550nm **Coating Specification:**

5.21 **Entrance Pupil Position (mm):**

7.83 **Object Space Principal Plane (mm):**

2.85 **Image Space Principal Plane (mm):**

-25.68 **Maximum Distortion (%):**

-4.99 **Exit Pupil Position (mm):**

MS **Lens Wavelength Range:**

## Sensor

1/3" **Maximum Sensor Format:**

1.40 **Pixel Size (μm):**

## Threading & Mounting

N/A **Filter Thread:**

S-Mbunt (M12 x 0.5) **Mount:**

## Regulatory Compliance

Compliant

RoHS 2015:

View

Certificate of Conformance:

Compliant

Reach 247:

## PRODUCT DETAILS

- Up to 1/2", S-Mount Lens
- Up to 5 MegaPixels, 1.4µm Pixel Size Sensors
- High Resolution Board Camera Lens Optimized for Close WD
- 2mm to 35mm Focal Length
- **Ruggedized Designs** Also Available

TECHSPEC® Blue Series M12 Lenses feature high resolution performance, along with the same great versatility of our **TECHSPEC® Green Series M12 Lenses**. Each lens consists of several precision glass elements mounted in a compact, aluminum housing. These lenses can connect to C-Mount cameras using the M12 x0.5 Adapter for C-Mount Cameras (**#53-675**) or the M12 x0.5 C-Mount Adapter with Rubber O-Ring (**#59-241**) for vibration-sensitive environments. TECHSPEC® Blue Series M12 Lenses are ideal for automotive, industrial, and medical imaging application. Prescription data is available by submitting a **Request for Prescription Form**.

**Note:** Compatible **TECHSPEC® M12 Imaging Lens Accessories** available.

Edmund Optics has created multiple product families of our TECHSPEC® M12 S-Mount Lenses, which are designed to provide high resolution. These high performance lenses feature precision glass designs in a metal housing and have optimized specifications between each product family to meet your application needs.

- Blue Series M12 Lenses: High resolution finite conjugate designs optimized for machine vision working distances.
- **Rugged Blue Series M12 Lenses:** **Stabilized ruggedization** versions of our Blue Series M12 Lenses, utilizing the same optics.
- **Green Series M12 Lenses:** Finite conjugate designs optimized for machine vision working distances.
- **Red Series M12 Lenses:** Infinite conjugate designs optimized for high resolution performance out to infinity.
- **HEO Series M12 Lenses:** Harsh Environment Optics (HEO) sealed versions of our Red Series M12 Lenses.
- **Liquid Lens M12 Lenses:** Integrated liquid lens for fast electronic focus.

## TECHNICAL INFORMATION

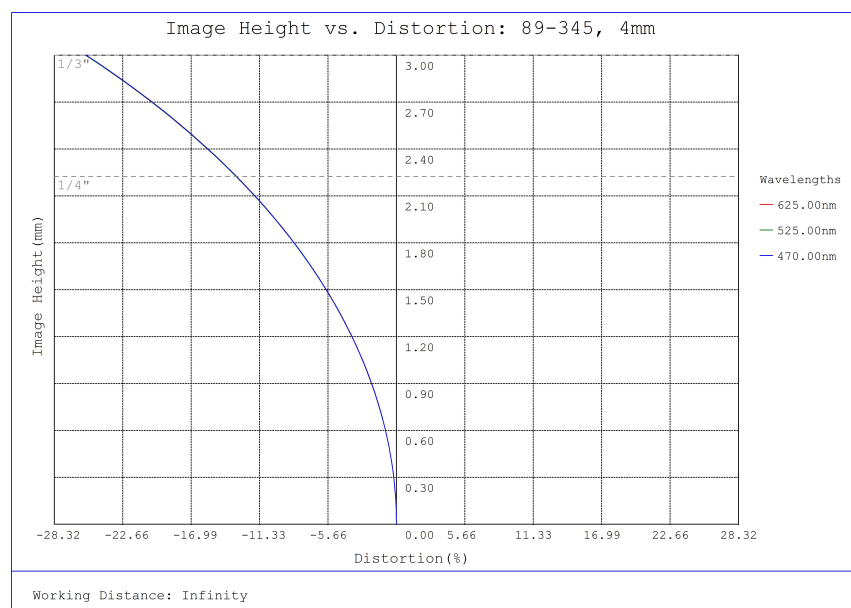

#89-345, 4mm FL f/4.0, Blue Series M12 Lens, Distortion Plot

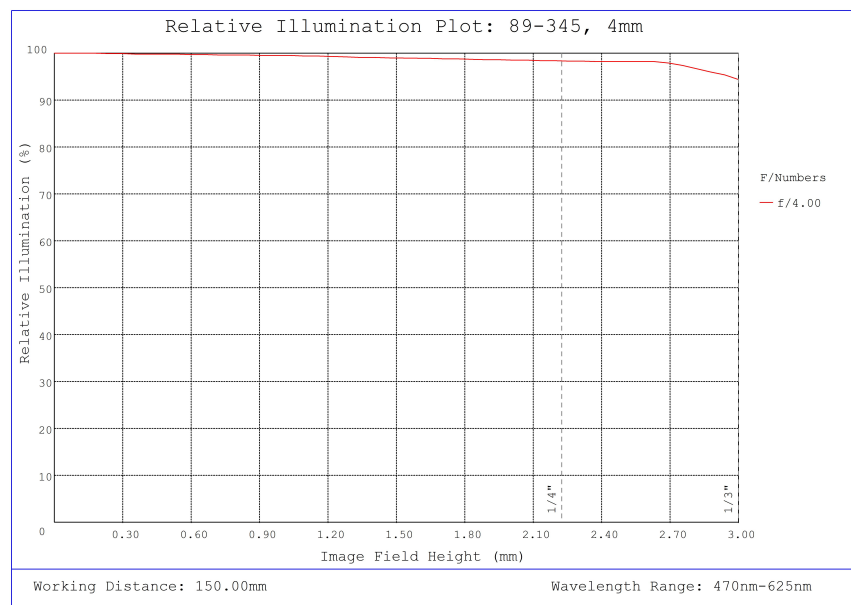

#89-345, 4mm FL f/4.0, Blue Series M12 Lens, Relative Illumination Plot

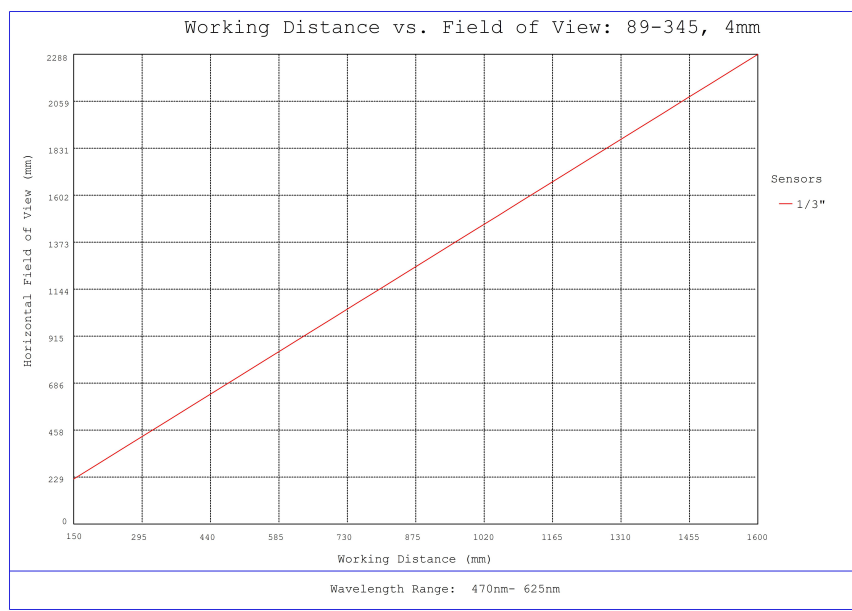

#89-345, 4mm FL f/4.0, Blue Series M12 Lens, Working Distance versus Field of View Plot

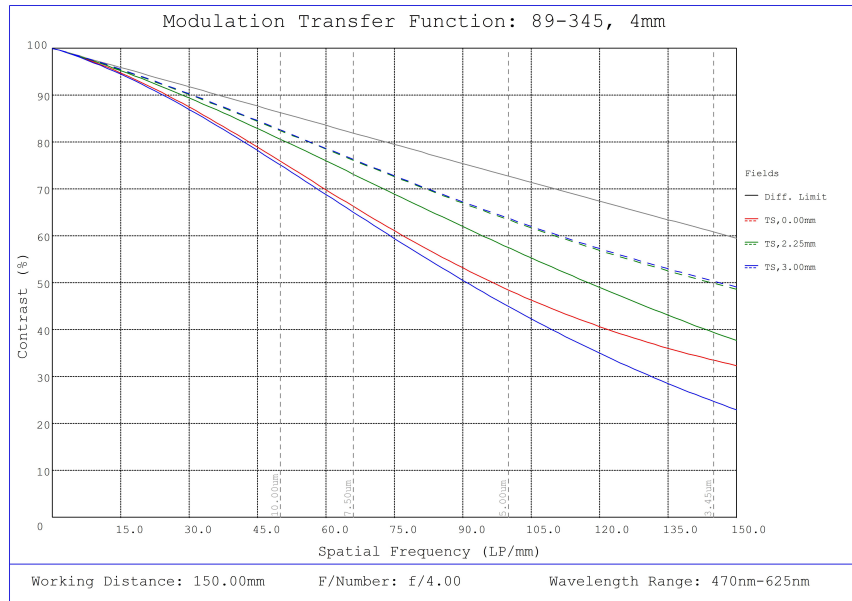

#89-345, 4mm FL f/4.0, Blue Series M12 Lens, Modulated Transfer Function (MTF) Plot, 150mm Working Distance, f4

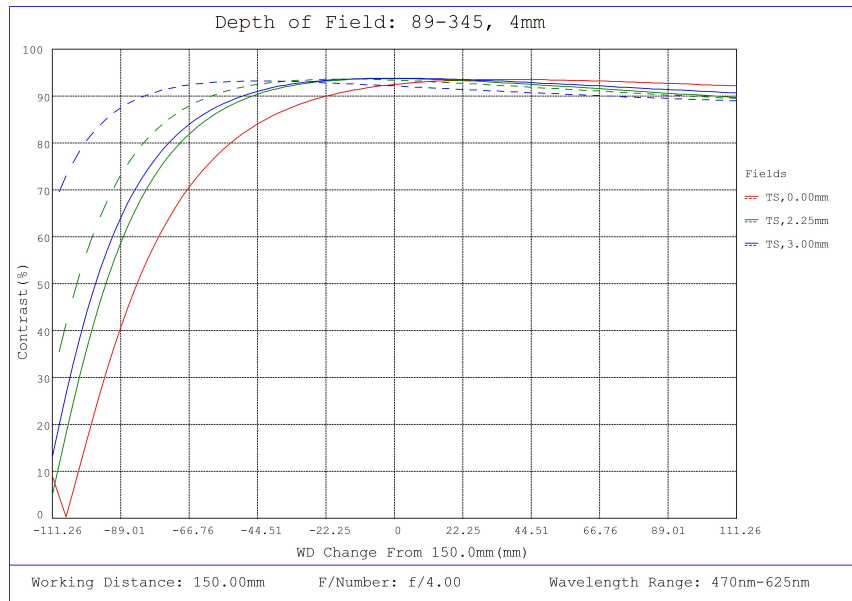

#89-345, 4mm FL f/4.0, Blue Series M12 Lens, Depth of Field Plot, 150mm Working Distance, f4

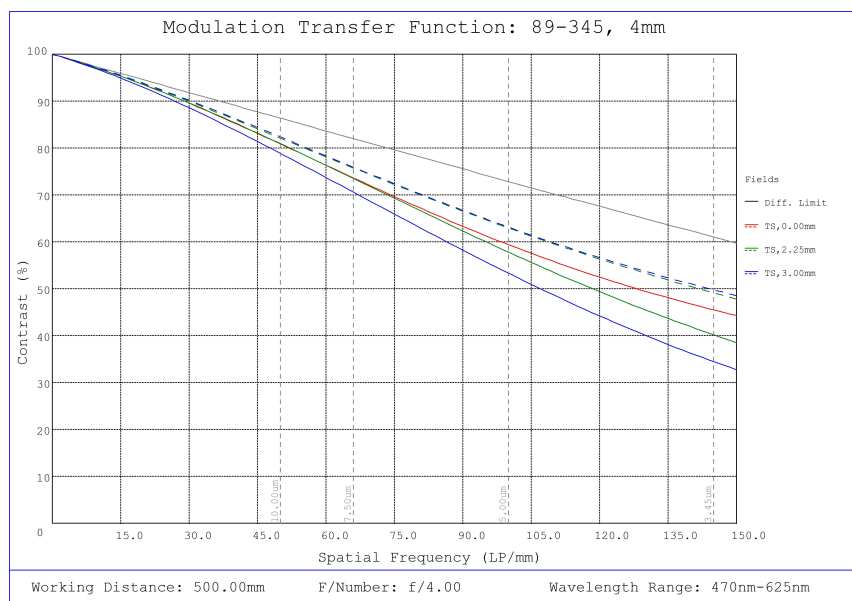

#89-345, 4mm FL f/4.0, Blue Series M12 Lens, Modulated Transfer Function (MTF) Plot, 500mm Working Distance, f4

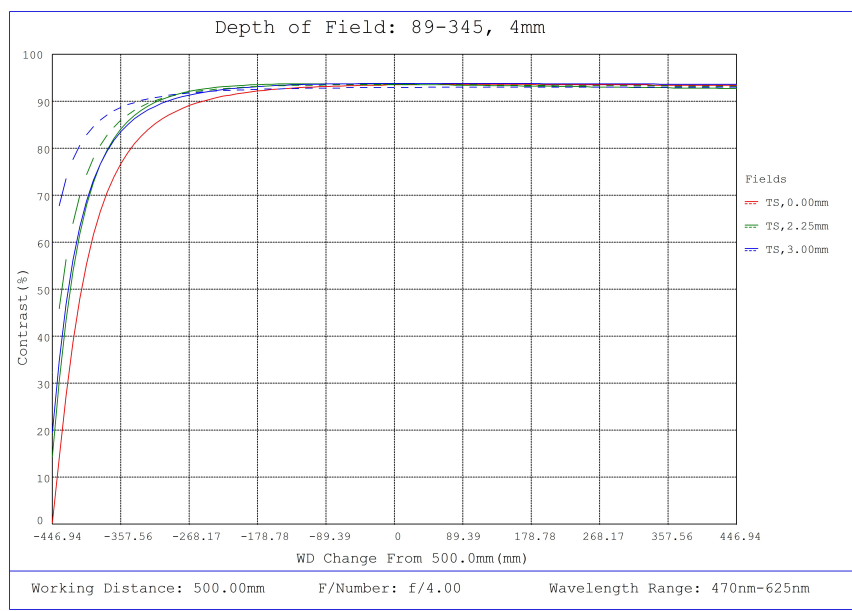

#89-345, 4mm FL f/4.0, Blue Series M12 Lens, Depth of Field Plot, 500mm Working Distance, f4

Focal Length	A	B	C*	D
2.0mm	18.0mm	21.7mm	2.26mm	4.75mm
3.0mm	14.0mm	17.1mm	4.8 - 4.7mm	5.8mm
4.0mm	14.0mm	19.7mm	6.1 - 6.0mm	4.4mm
5.0mm	14.0mm	14.6mm	4.0 - 3.9mm	3.7mm
6.0mm	14.0mm	14.1mm	6.9 - 6.8mm	4.5mm
8.0mm	14.0mm	12.3mm	8.8 - 8.6mm	3.7mm
10.0mm	14.0mm	17.0mm	6.6 - 6.3mm	3.7mm
12.5mm	15.0mm	22.9mm	10.1 - 9.7mm	4.8mm
17.5mm	14.0mm	20.7mm	5.8 - 4.9mm	7.6mm
25.0mm	18.0mm	30.0mm	8.5 - 6.5mm	11.5mm
35.0mm	18.0mm	29.5mm	18.72 - 14.0mm	14.5mm

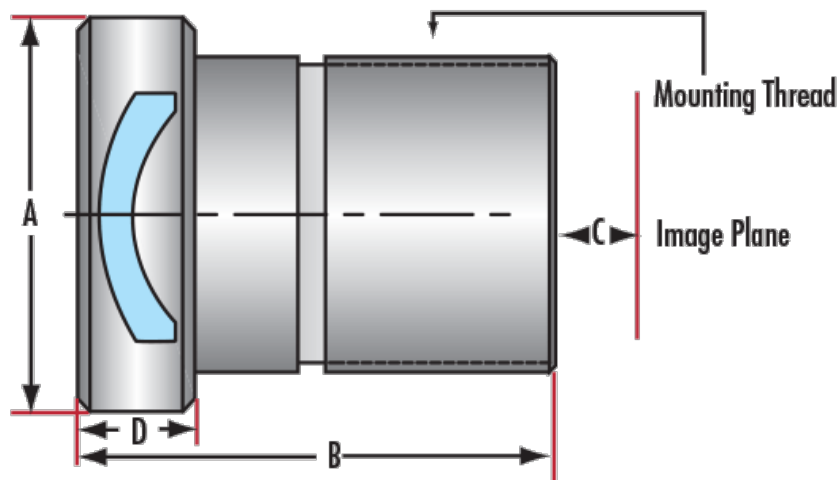

\*Specified for Optimized Working Distance of 150 - 250mm.