

**TECHSPEC® 50.8mm Length, M6 Thread, Post Holder**



Stock #58-972 **20+ In Stock**

⊖ 1 ⊕ €15<sup>25</sup>

**ADD TO CART**

Volume Pricing	
Qty 1-9	€15,25 each
Qty 10+	€14,80 each
Need More?	<a href="#">Request Quote</a>

ⓘ Prices shown are exclusive of VAT/local taxes

Product Downloads

**General**

Metric Type:

**Physical & Mechanical Properties**

50.80 Length (mm):

**Optical Properties**

Substrate:

## Threading & Mounting

Mounting Threads:  
M6 x 1.0

## Regulatory Compliance

Compliant **RoHS 2015:**

Compliant **Reach 224:**

[View](#) **Certificate of Conformance:**

## Product Details

- English & Metric Post Holders
- English: 1/4-20 Base
- Metric: M6x1 Base
- Unique 3-Point Contact Design
- Aluminum with Brass Inserts

Post Holders have a unique 3-point contact design that inherently centers our [Stainless Steel Optical Mounting Posts](#) more accurately. The three contact pads run the entire inside length of each holder, thus ensuring a more accurate fit with our Posts. Additionally, three tapped holes allow thumbscrew orientation without removing the Post Holder from the breadboard table, base plate, or other fixture. Post hole depth is Post Holder length less 0.25" (6.35mm). Thread values are laser engraved on each Post Holder for quick integration. Locking thumbscrew included.

## Technical Information

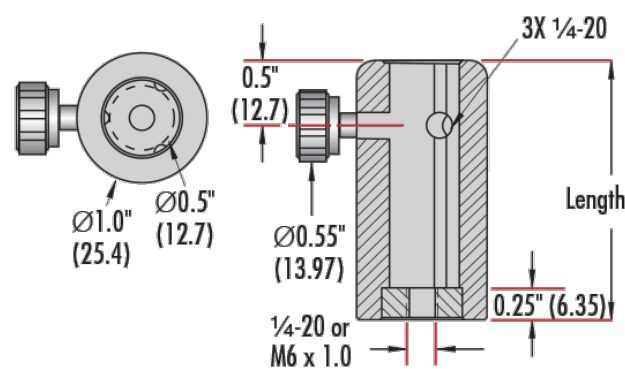

Description	Qty	Stock No.
Post Holder, 1" Length	1	<a href="#">#58-976</a>
Post Holder, 1.5" Length	1	<a href="#">#58-977</a>
Post Holder, 2" Length	2	<a href="#">#58-978</a>
Post Holder, 3" Length	2	<a href="#">#58-979</a>
Post Holder, 4" Length	1	<a href="#">#58-980</a>
Post Holder, 6" Length	1	<a href="#">#58-981</a>

Description	Qty	Stock No.
Post Holder, 25.4mm Length	1	<a href="#">#58-970</a>
Post Holder, 38.1mm Length	1	<a href="#">#58-971</a>
Post Holder, 50.8mm Length	2	<a href="#">#58-972</a>
Post Holder, 76.2mm Length	2	<a href="#">#58-973</a>
Post Holder, 101.6mm Length	1	<a href="#">#58-974</a>
Post Holder, 152.4mm Length	1	<a href="#">#58-975</a>