

[See all 12 Products in Family](#)

50X T1.1 Mitutoyo LCD Plan Apo NIR Infinity Corrected Objective

See More by [Mitutoyo](#)



Stock #23-599 **1 In Stock**

⊖ 1 ⊕ €5.170⁰⁰

ADD TO CART

Volume Pricing

Qty 1+	€5.170,00 each
Need More?	Request Quote

ⓘ Prices shown are exclusive of VAT/local taxes

Product Downloads

General

378-828-16 **Model Number:**

Compatible Tube Lens Focal Length (mm):
Focal Length: 200mm

Microscope Objective **Type:**

Infinity Corrected	Style:
Mitutoyo	Manufacturer:
1.1mm thick LCD cover-glass Example Application: High magnification inspection through liquid crystal glass (LCD) or cutting and trimming of semiconductor wafer and circuits	Note:

Physical & Mechanical Properties

77.87	Length excluding Threads (mm):
34	Maximum Diameter (mm):
320.00	Weight (g):

Optical Properties

1.1	Compatible Cover Glass Thickness (mm):
532, 1064	Design Wavelength DWL (nm):
0.13mm	Horizontal Field of View, 1/2" Sensor:
0.18mm	Horizontal Field of View, 2/3" Sensor:
4.00	Focal Length FL (mm):
50X	Magnification:
0.42	Numerical Aperture NA:
0.7	Resolving Power (μm):
1.60	Depth of Field (μm):
0.48	Field of View, 24 Diameter Field Eyepiece (mm):
0.36	Field of View, 18 Diameter Field Eyepiece (mm):
17.13	Working Distance (mm):
480 - 1800	Wavelength Range (nm):
95.37	Parfocal Length (mm):
N/A	Immersion Liquid:

Sensor

2/3"	Maximum Sensor Format:
------	-------------------------------

Threading & Mounting

M26 x 36 TPI	Mounting Threads:
--------------	--------------------------

Environmental & Durability Factors

23 ±2	Performance Assurance Temperature (°C):
-------	--

Regulatory Compliance

Exempt	RoHS 2015:
View	Certificate of Conformance:
Contains SVHC(s)	REACH 241:

Product Details

- Ideal for Brightfield Imaging and Laser-Based Applications through LCD Glass
- Excellent Performance at Nd:YAG Laser Lines

- Compensate for Cover-Glass Thickness of 0.7mm or 1.1mm

Mitutoyo NIR, NUV, and UV LCD Infinity Corrected Objectives combine the benefits of the standard MPlan Apo and MPlan Apo SL series objectives with enhanced spectral ranges. The NIR objectives are corrected from 480 to 1800nm, making them ideal for semiconductor and telecommunication inspection, or for laser cutting with common Nd:YAG lasers. The HR series offers an increased numerical aperture, providing smaller spot sizes and higher resolution. Mitutoyo NIR, NUV, and UV LCD Infinity Corrected Objectives compensate for common LCD glass thicknesses. The NUV and UV series of objectives have excellent performance at the second, third, and fourth Nd:YAG harmonics of 532nm, 355nm, and 266nm respectively.

Technical Information

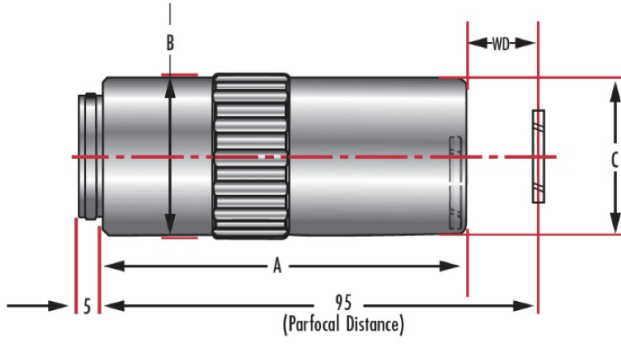

Units: mm

Dimensions				
M Plan NIR	A (mm)	B (mm)	C (mm)	W.D. (mm)
20X, T0.7	75.00	34	32.2	20.0
20X, T1.1	75.02	34	32.2	19.98
50X, T0.7	78.04	34	32.2	17.26
50X, T0.7 HR	77.74	34	32.2	9.60
50X, T1.1	77.87	34	32.2	17.13
100X	82.94	34	32.2	12.06
HR 100X	85.13	39	37	9.87
M Plan NUV	A (mm)	B (mm)	C (mm)	W.D. (mm)
20X, T0.7	78	34	32.2	16.96
50X, T0.7	80	34	32.2	14.76
100X, T1.1	83.97	34	32.2	11.03
M Plan UV	A (mm)	B (mm)	C (mm)	W.D. (mm)
20X, T0.7	80	34	32.2	14.98
50X, T0.7	83	34	32.2	12.38