

[See all 102 Products in Family](#)

TECHSPEC® 6.0mm Diameter x 18.0mm FL, 1064nm V-Coat, PCX Lens



633nm Laser Line Coated Plano-Convex(PCX) Lenses



Stock **#65-531** **8 In Stock**

[Other Coating Options](#)

⊖ 1 ⊕ €49.⁰⁰

ADD TO CART

Volume Pricing	
Qty 1-9	€49,50 each
Qty 10-25	€44,50 each
Qty 26-49	€39,50 each
Need More?	Request Quote

ⓘ Prices shown are exclusive of VAT/local taxes

Product Downloads

General

Plano-Convex Lens **Type:**

Physical & Mechanical Properties

6.00 +0.0/-0.025	Diameter (mm):
<1	Centering (arcmin):
1.42 ±0.05	Center Thickness CT (mm):
0.90	Edge Thickness ET (mm):
5.4	Clear Aperture CA (mm):
Protective as needed	Bevel:

Optical Properties

18.00 @ 587.6nm	Effective Focal Length EFL (mm):
17.07	Back Focal Length BFL (mm):
Laser V-Coat (1064nm)	Coating:
R _{abs} <0.25% @ 1064nm	Coating Specification:
N-BK7	Substrate: <input type="checkbox"/>
40-20	Surface Quality:
1.5λ	Power (P-V) @ 632.8nm:
λ/4	Irregularity (P-V) @ 632.8nm:
±1	Focal Length Tolerance (%):
9.30	Radius R₁ (mm):
3.00	f#:
0.17	Numerical Aperture NA:
1064	Design Wavelength DWL (nm):
5 J/cm ² @ 1064nm, 10ns	Damage Threshold, By Design: <input type="checkbox"/>

Regulatory Compliance

Compliant	RoHS 2015:
View	Certificate of Conformance:
Compliant	Reach 235:

Need different specs or modifications?

Edmund Optics offers comprehensive custom manufacturing services for optical and imaging components tailored to your specific application requirements. Whether in the prototyping phase or preparing for full-scale production, we provide flexible solutions to meet your needs. Our experienced engineers are here to assist—from concept to completion.

Our capabilities include:

- Custom dimensions, materials, coatings, and more
- High-precision surface quality and flatness
- Tight tolerances and complex geometries
- Scalable production—from prototype to volume

Learn more about our [custom manufacturing capabilities](#) or submit an inquiry [here](#).

Product Details

- <0.25% Reflection at 1064nm for Fiber and Nd:YAG Applications
- BBAR Coating Options Also Available: [uncoated](#), [MgF₂](#), [VIS 0°](#), [VIS-NIR](#), [NIR I](#), [NIR II](#)
- [405nm](#), [532nm](#), [633nm](#), [785nm](#), [980nm](#), 1064nm, and [1550nm](#) V-Coated Options Offered

TECHSPEC® 1064nm Laser Line Coated Plano-Convex (PCX) Lenses are designed for maximum throughput at the specified laser wavelength. These lenses are ideal for collecting and focusing light from laser sources and their corresponding harmonics. With a maximum reflection of <0.25% per surface at the design wavelength, the lenses will provide superior transmission in applications utilizing multiple optical components. TECHSPEC® 1064nm Laser Line Coated Plano-Convex (PCX) Lenses are available Laser V-Coated in a range of other wavelengths: [405nm](#), [532nm](#), [633nm](#), [785nm](#), [980nm](#), and [1550nm](#). Other coating options are available, including [uncoated](#), [MgF₂](#), [VIS 0°](#), [VIS-NIR](#), [NIR I](#), and [NIR II](#).

Technical Information

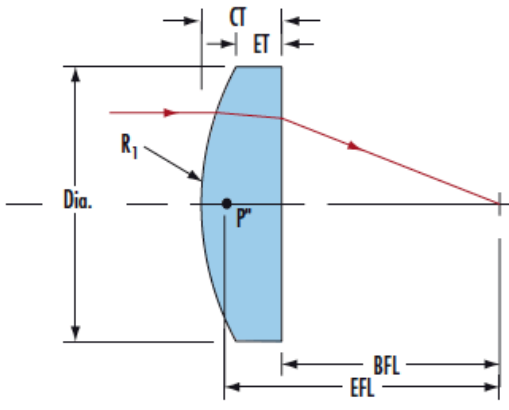

Compatible Mounts

;