

TECHSPEC® 6mm Diameter, S-Mount Thin Optic Mount



Stock #63-941 **20+ In Stock**

- 1 + €40⁷⁵

ADD TO CART

Volume Pricing	
Qty 1-4	€40,75 each
Qty 5-9	€36,60 each
Qty 10-25	€34,00 each
Need More?	Request Quote

Prices shown are exclusive of VAT/local taxes

Product Downloads

General

Fixed **Type:**

Optic Mount (Fixed) **Function:**

Type of Optics:

Circular

Physical & Mechanical Properties

5.6 Extension Length (mm):

8.6 Total Length (mm):

1.0 Min. Thickness of Compatible Optics (mm):

3.0 Max. Thickness of Compatible Optics (mm):

5.2 Clear Aperture CA (mm):

16.0 Outer Diameter (mm):

Threading & Mounting

S-Mount Thread Type:

6.0 Diameter of Compatible Optics (mm):

Regulatory Compliance

Compliant RoHS 2015:

View Certificate of Conformance:

Compliant REACH 241:

Product Details

- Mounts for Simple Lenses, Achromats, Filters, or Reticles
- Designed to Integrate with Any C, S, or T-Mount Components
- Optic is Held in Place with Included Retaining Ring

TECHSPEC® C, S, and T-Mount Circular Optic Mounts are designed to mount a variety of circular optical components into C, S, or T-Mount compatible systems. An included threaded retainer ring, designed to accept a standard spanner wrench, securely holds the optical component. These circular optic mounts are compatible with a wide variety of Edmund Optics optomechanical components utilizing C, S, or T-Mount threads, such as [extension tubes](#) and [kinematic mounts](#). TECHSPEC® C, S, and T-Mount Circular Optic Mounts are threaded for 1" x 32TPI, M12 x 0.5, or M42 x 0.75 mounting, with 30mm, 16mm, and 48mm outer diameters, respectively. These mounts are ideal for creating and personalization of a diverse range of optical systems.

Note: #56-353, #56-354, #52-933, and #52-292 are all 3-part assemblies

Technical Information

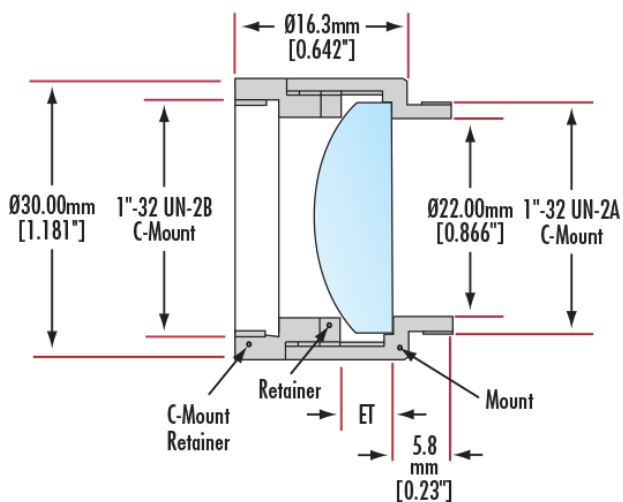
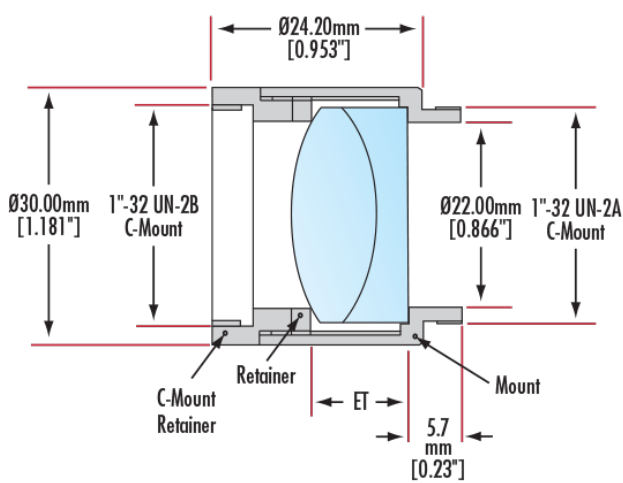



S-Thread Simple / Thin Lens Mount



S-Thread Simple / Thin Lens Mount



S-Thread Achromat / Thick Lens Mount





#58-741

