

[See all 24 Products in Family](#)

TECHSPEC® 8.5mm C Series Fixed Focal Length Lens



8.5mm Focal Length, #58-000



Stock #58-000 **20+ In Stock**

− 1 + €275⁰⁰

ADD TO CART

Volume Pricing	
Qty 1+	€275,00 each
Need More?	Request Quote

Prices shown are exclusive of VAT/local taxes

Product Downloads

General

C Series **Product Family:**

Fixed Focal Length Lens **Type:**

Compact Lens **Imaging Lens Type:**

Physical & Mechanical Properties

Variable	Iris Option:
34.50	Length (mm):
32	Maximum Diameter (mm):
32	Outer Diameter (mm):
80	Weight (g):
0	Maximum Rear Protrusion (mm):

Optical Properties

Horizontal Field of View @ Max Sensor Format:
60.6°

Field of View at Max Sensor Format:
Horizontal: 60.4°
Vertical: 44.9°
Diagonal: 76.7°

60.4° Horizontal Field of View, 2/3" Sensor:

49.2° Horizontal Field of View, 1/1.8" Sensor:

43.6° Horizontal Field of View, 1/2" Sensor:

39.5° Horizontal Field of View, 1/2.5" Sensor:

32.6° Horizontal Field of View, 1/3" Sensor:

24.4° Horizontal Field of View, 1/4" Sensor:

11.00 Maximum Image Circle (mm):

0.0289 Numerical Aperture NA, Object Side:

7 (5) Number of Elements (Groups):

8.50 Focal Length FL (mm):

100 - ∞ Working Distance (mm):

f/1.3 - f/16 Aperture (f/#):

425 - 675nm BBAR Coating:

425 - 675nm BBAR Coating Specification:

8.22 Entrance Pupil Position (mm):

14.08 Object Space Principal Plane (mm):

6.67 Image Space Principal Plane (mm):

-18.4 Maximum Distortion (%):

-12.23 Exit Pupil Position (mm):

VIS Lens Wavelength Range:

Sensor

2/3" Maximum Sensor Format:

2.74 Pixel Size (μm):

Threading & Mounting

M25.5 x 0.50 (Female) Filter Thread:

C-Mount Mount:

Environmental & Durability Factors

Storage Temperature (°C):

-20 to +60

Regulatory Compliance

RoHS 2015:

Compliant

Certificate of Conformance:

[View](#)

Reach 247:

Compliant

Product Details

- Up to 2/3", C-Mount Lens
- Up to 7.5 MegaPixels, 2.8µm Pixel Size Sensors
- Compact (C), FA Lens for Machine Vision
- 3.5mm to 100mm Focal Length

TECHSPEC® C Series Fixed Focal Length Lenses are designed for use in machine vision applications with the working distance and resolution requirements of factory automation and inspection in mind. TECHSPEC® C Series Fixed Focal Length Lenses feature large maximum apertures, allowing these high performance lenses to be used in even the most restrictive lighting conditions. Each lens has a broadband anti-reflection coating, locking iris and focus adjustment with recessed set screws, and a ruggedized, robust housing for space-restrictive applications. C Series lenses are manufactured to high tolerances, which result in high levels of imaging performance with low lens-to-lens variation. Through combining optical performance, industrial features, and compact package sizes, our TECHSPEC® C Series Fixed Focal Length Lenses are ideal for use in factory automation and inspection.

Edmund Optics has created a family of high performance optical designs (the C Series family) and developed 6 customized optomechanical solutions targeted for specific applications. These lens sub-families utilize the same optics as the C Series lenses providing the same optical performance in a variety of optomechanical solutions to meet your application requirements:

- **C Series:** Features locking cam focus and iris adjustment and is the most adjustable version of these optical designs; they are the typical high quality machine vision lenses. Also available with a [VIS-NIR Broadband Anti-Reflection \(BBAR\)](#) or [SWIR](#) Coating
- **Ci Series:** Simplified mechanics featuring fixed apertures with compact housing. [Industrial Ruggedization](#) for reduced size, cost, and locked focus.
- **Cr Series:** All optics glued in place and a locking C-clamp focus ring. [Stabilized Ruggedization](#) for reduced pixel shift and improved focus stability.
- **Cx Series:** Modular, flexible mechanics allows lenses to be taken apart for easy integration of accessories such as liquid lenses, apertures, and more.
- **Liquid Lens Cx Series:** Designed with an integrated liquid lens for quick autofocus.
- **Cw Series:** Waterproof, designed to meet IEC [Ingress Protection](#) Code IPX7 and IPX9K.

Technical Information

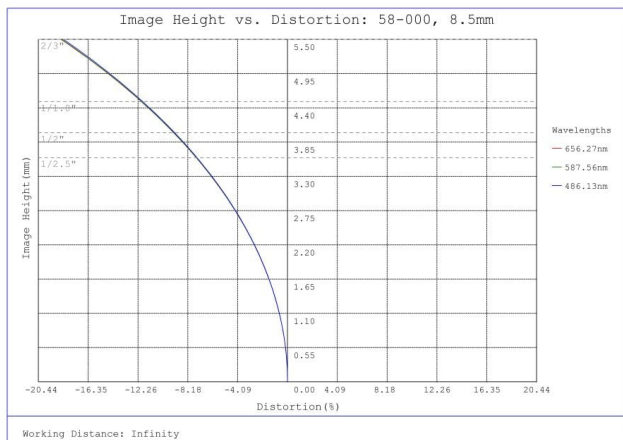

#58-000, 8.5mm C Series Fixed Focal Length Lens, Distortion Plot

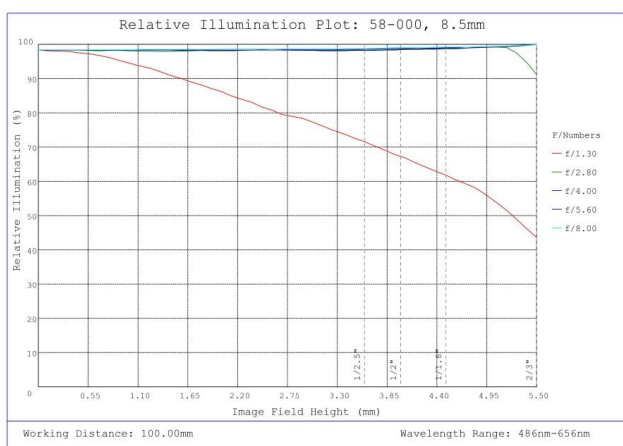

#58-000, 8.5mm C Series Fixed Focal Length Lens, Relative Illumination Plot

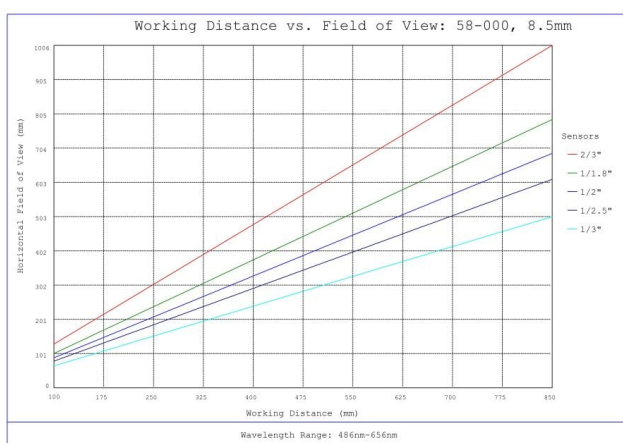

#58-000, 8.5mm C Series Fixed Focal Length Lens, Working Distance versus Field of View Plot

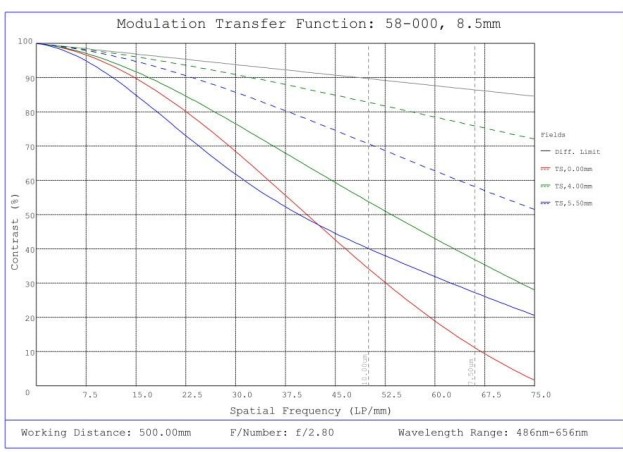

#58-000, 8.5mm C Series Fixed Focal Length Lens, Modulated Transfer Function (MTF) Plot, 500mm Working Distance, f2.8

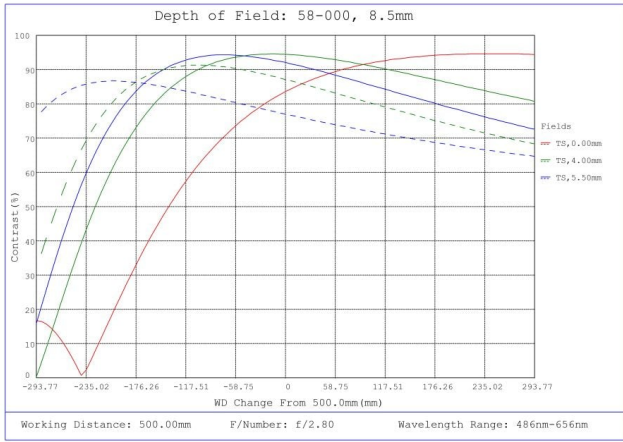

#58-000, 8.5mm C Series Fixed Focal Length Lens, Depth of Field Plot, 500mm Working Distance, f2.8

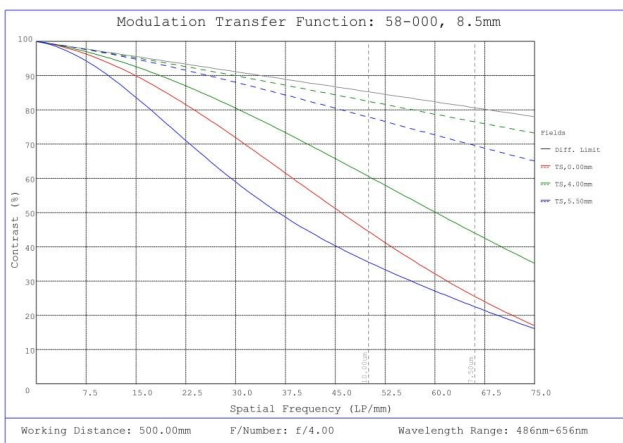

#58-000, 8.5mm C Series Fixed Focal Length Lens, Modulated Transfer Function (MTF) Plot, 500mm Working Distance, f4

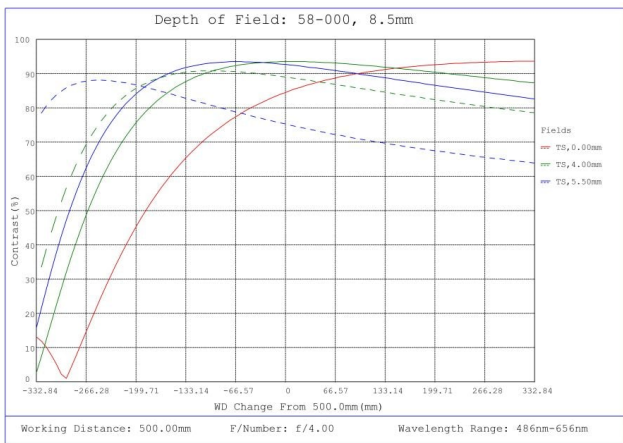

#58-000, 8.5mm C Series Fixed Focal Length Lens, Depth of Field Plot, 500mm Working Distance, f4

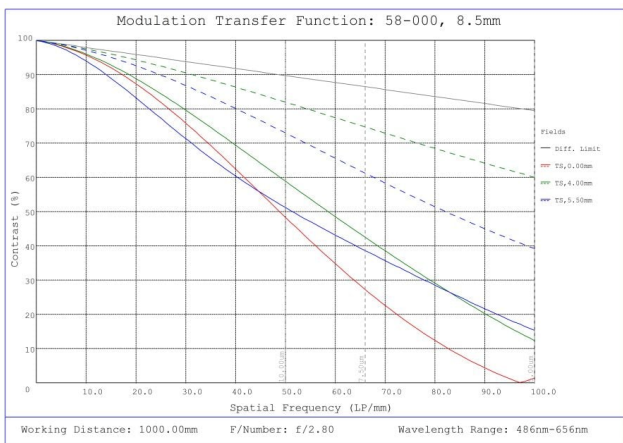

#58-000, 8.5mm C Series Fixed Focal Length Lens, Modulated Transfer Function (MTF) Plot, 1000mm Working Distance, f2.8

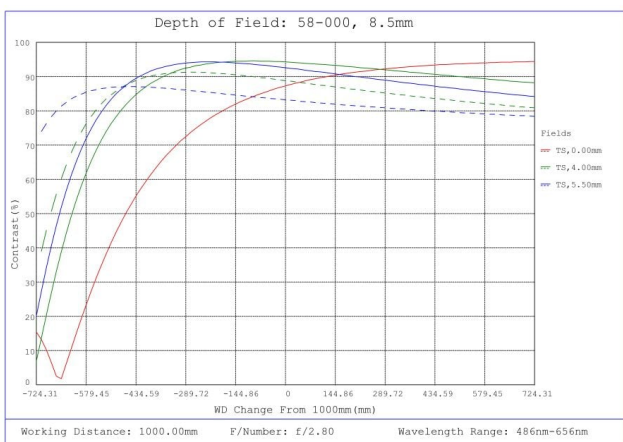

#58-000, 8.5mm C Series Fixed Focal Length Lens, Depth of Field Plot, 1000mm Working Distance, f2.8

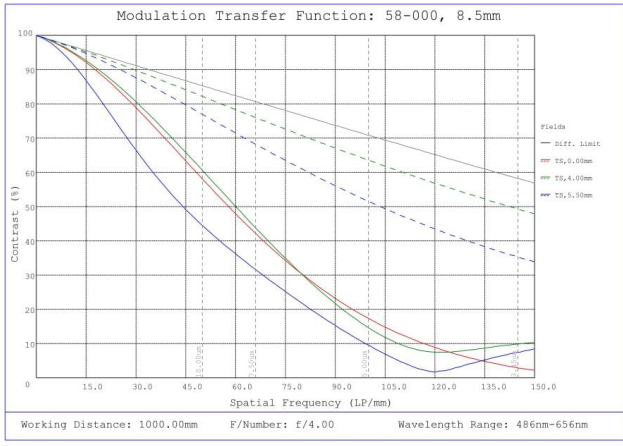

#58-000, 8.5mm C Series Fixed Focal Length Lens, Modulated Transfer Function (MTF) Plot, 1000mm Working Distance, f4

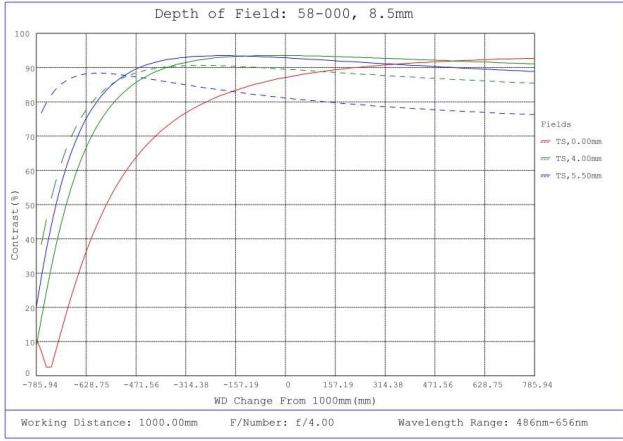

#58-000, 8.5mm C Series Fixed Focal Length Lens, Depth of Field Plot, 1000mm Working Distance, f4

Focal Length	A	B	C	D
3.5mm	50.0mm	39.3mm	32.0mm	2.72mm
4.5mm	40.0mm	37.5mm	32.0mm	2.78mm
6.0mm	36.0mm	48.9mm	35.8mm	1.4mm
8.5mm	32.0mm	34.5mm	32.0mm	0.0mm
12mm	32.0mm	27.9mm	32.0mm	0.5mm
16mm	33.0mm	40.5mm	33.0mm	1.0mm
25mm	31.0mm	30.5mm	31.0mm	1.3mm
35mm	33.0mm	41.0mm	33.0mm	0.0mm
50mm	35.8mm	53.7mm	35.8mm	2.85mm
100mm	52.0mm	93.5mm	41.0mm	7.0mm

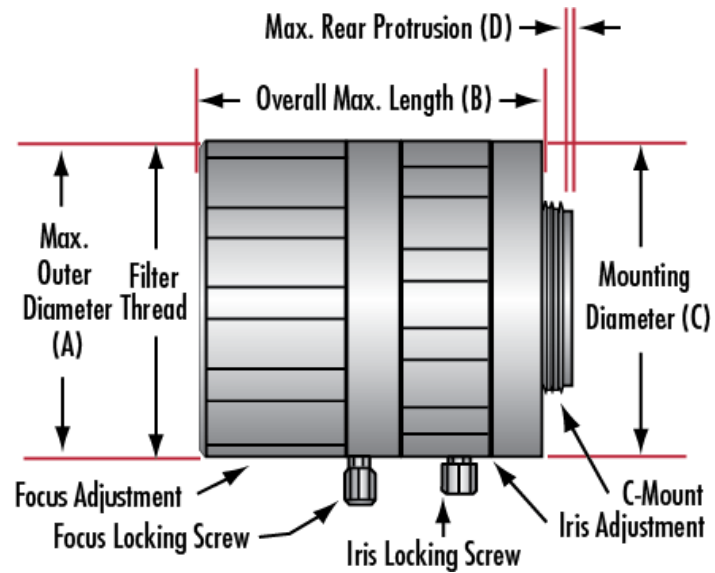

Compatible Cameras