

9.0mm Optic Dia., Optic Mount



Optic Component Mounts

Stock #64-553 **8 In Stock**

€32⁷⁵

ADD TO CART

Volume Pricing	
Qty 1-9	€32,75 each
Qty 10+	€29,60 each
Need More?	Request Quote

ⓘ Prices shown are exclusive of VAT/local taxes

Product Downloads

General

Fixed **Type:**
Circular **Type of Optics:**

Physical & Mechanical Properties

6.0 **Clear Aperture CA (mm):**

30.0	Outer Diameter (mm):
12.00	Thickness (mm):
Black Anodized Aluminum	Construction:
6.00	Max. Thickness of Compatible Optics (mm):

Threading & Mounting

9.0	Size of Compatible Optics (mm):
M6 x 1.0, 1/4-20	Compatible Post:

Regulatory Compliance

Compliant	RoHS 2015:
View	Certificate of Conformance:
Compliant	Reach 247:

Product Details

- Simple Mounting Arrangement
 - Metric and English Configurations
 - Black Anodized Aluminum Construction
 - [Posts](#) and [Post Holders](#) Required for Mounting
- Optic Component Mounts are designed to hold lenses, filters, mirrors, and other optical components. The included retainer ring securely holds the component in place. Optic Component Mounts need the required [posts](#) and [post holders](#) for mounting to a breadboard. Both English (1/4-20) and Metric (M6) standard posts are accepted by the mounts. These mounts are constructed of black anodized aluminum in a simple mounting arrangement.

Technical Information

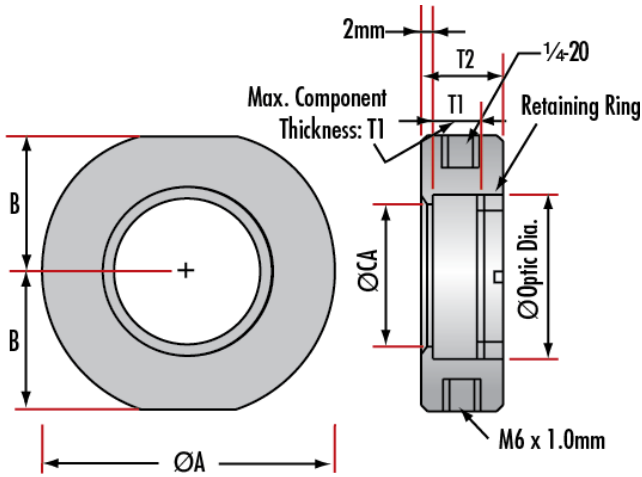

Maximum Optic Diameter	Clear Aperture (CA)	Mount Diameter A	B	Maximum Optic Thickness T1	Mount Thickness T2	Stock No.
5	4	30	13.5	5.7	12	#64-551
6	5	30	13.5	5.7	12	#64-552
9	6	30	13.5	6	12	#64-553
10	7	30	13.5	6	12	#64-554
12	9	35	16.0	10	16	#64-555
12.7	9.5	35	16.0	10	16	#64-556
15	12	35	16.0	10	16	#64-557
18	15	40	19.0	12	18	#64-558
20	17	40	19.0	12	18	#64-559
25	22	45	21.5	10	16	#64-560
25.4	22	45	21.5	10	16	#64-561
25.4	22	45	21.5	13	19	#65-562
30	26	50	24.0	6	12	#64-563
30	26	50	24.0	12	18	#64-564
38.1	34	60	29.0	12	18	#64-565
40	36	60	29.0	12	18	#64-566
50	46	70	34.0	12	18	#64-567
50	46	70	34.0	18	24	#64-568
50.8	46	70	34.0	12	28	#64-569

