

**TECHSPEC® f/4, 6mm Focal Length Green Series M12 Lens**



6mm Focal Length

Stock #69-256 **6 In Stock**

⊖ 1 ⊕ €83.<sup>00</sup>

**ADD TO CART**

Volume Pricing	
Qty 1+	€83,00 each
Need More?	<a href="#">Request Quote</a>

ⓘ Prices shown are exclusive of VAT/local taxes

Product Downloads

**SPECIFICATIONS**

**General**

Green Series

Series:

M12 Imaging Lens

Type:

No IR Cut Filter:

Standard Lens Imaging Lens Type:

## Physical & Mechanical Properties

Fixed Iris Option:

11.70 Length (mm):

14 Maximum Diameter (mm):

14 Outer Diameter (mm):

3 Weight (g):

## Optical Properties

Horizontal Field of View @ Max Sensor Format:  
130.9mm - 46.5°

Field of View at Max Sensor Format:  
Horizontal: 129.8mm - 46°  
Vertical: 95.2mm - 34.6°  
Diagonal: 168.5mm - 57.7°

Horizontal Field of View, 1/3" Sensor:  
129.8mm - 46.2°

Horizontal Field of View, 1/4" Sensor:  
95.1mm - 34.7°

80 lp/mm @ 20% Contrast Resolution:

6.00 Maximum Image Circle (mm):

0.0047 Numerical Aperture NA, Object Side:

5(5) Number of Elements (Groups):

400 - 700 Wavelength Range (nm):

6.00 Focal Length FL (mm):

150 - ∞ Working Distance (mm):

f/4 Aperture (f/#):

-8.27 @ Full Field Distortion (%):

4.0 - 3.9 Back Focal Length BFL (mm):

N4 MgF<sub>2</sub> @ 580nm Coating Specification:

3.99 Entrance Pupil Position (mm):

6.38 Object Space Principal Plane (mm):

-1.43 Image Space Principal Plane (mm):

-8.27 Maximum Distortion (%):

-5.43 Exit Pupil Position (mm):

VS Lens Wavelength Range:

## Sensor

1/3" Maximum Sensor Format:

8.30 Pixel Size (μm):

## Threading & Mounting

N/A Filter Thread:

M12 x 0.5 Mounting Threads:

Mount:

## Regulatory Compliance

Compliant

RoHS 2015:

View

Certificate of Conformance:

Compliant

REACH 241:

## PRODUCT DETAILS

- Up to 1/2", S-Mount Lens
- Up to 0.4 MegaPixels, 8.3µm Pixel Size Sensors
- Board Camera Lens Optimized for Close WD and Finite Conjugate
- 6mm to 25mm Focal Lengths

TECHSPEC® Green Series M12 Lenses designed for use in compact and board level cameras provide excellent image quality in a small, versatile package. Optimized to cover 1/3" and 1/2" sensor formats and weighing only a few grams, these machine vision lenses meet the most demanding space and weight restrictions. Each lens is threaded for M12 x0.5, except the 25.0mm focal length option (#54-855). TECHSPEC® Green Series M12 Lenses are ideal for wide angle and close focus applications, large area inspect for the automotive, forensic, pharmaceutical, and food industries. Prescription data is available by submitting a [Request for Prescription Form](#).

**Note:** Compatible [TECHSPEC M12 Imaging Lens Accessories](#) available.

Edmund Optics has created multiple product families of our TECHSPEC® M12 S-Mount Lenses, which are designed to provide high resolution. These high performance lenses feature precision glass designs in a metal housing and have optimized specifications between each product family to meet your application needs.

- **Blue Series M12 Lenses:** High resolution finite conjugate designs optimized for machine vision working distances.
- **Rugged Blue Series M12 Lenses:** Stabilized ruggedization versions of our Blue Series M12 Lenses, utilizing the same optics.
- **Green Series M12 Lenses:** Finite conjugate designs optimized for machine vision working distances.
- **Red Series M12 Lenses:** Infinite conjugate designs optimized for high resolution performance out to infinity.
- **HEO Series M12 Lenses:** Harsh Environment Optics (HEO) sealed versions of our Red Series M12 Lenses.
- **Liquid Lens M12 Lenses:** Integrated liquid lens for fast electronic focus.

## TECHNICAL INFORMATION

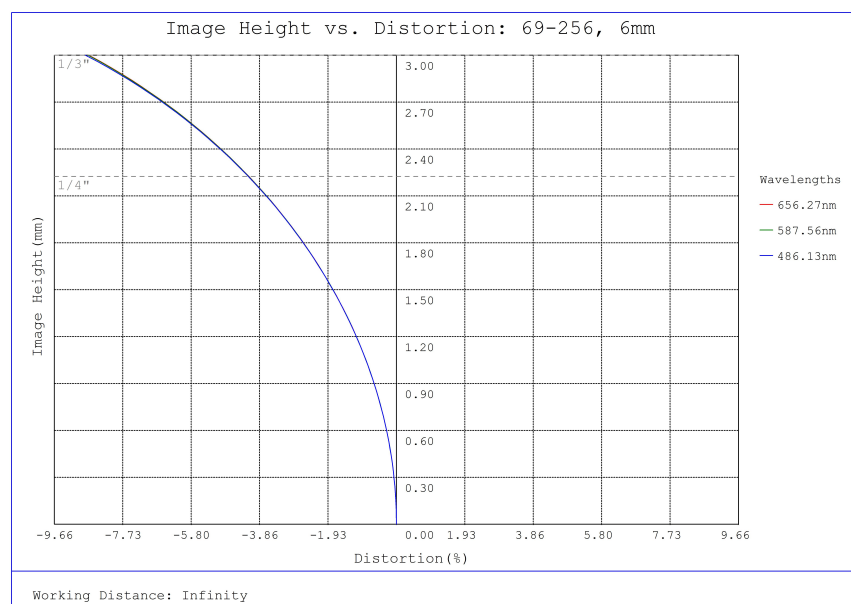

#69-256, f/4, 6mm Focal Length Green Series M12 Lens, Distortion Plot

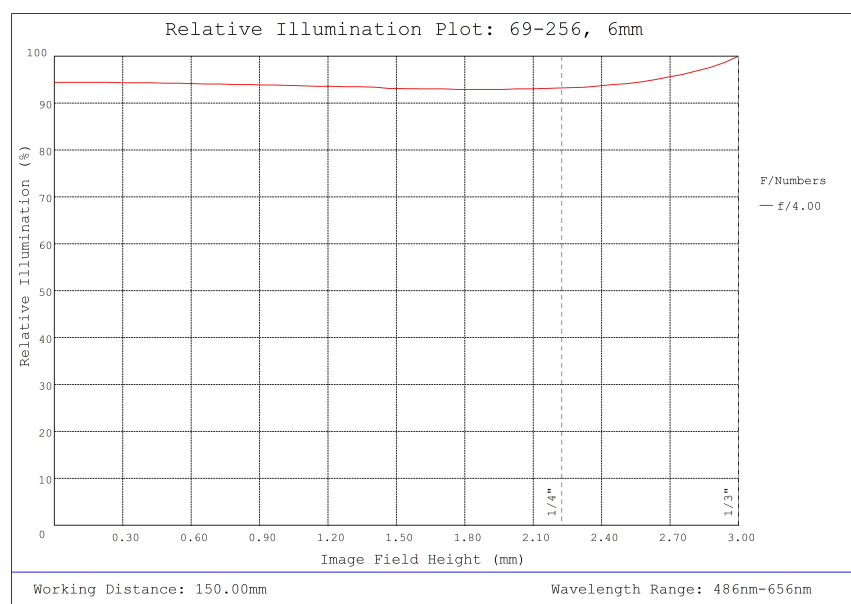

#69-256, f/4, 6mm Focal Length Green Series M12 Lens, Relative Illumination Plot

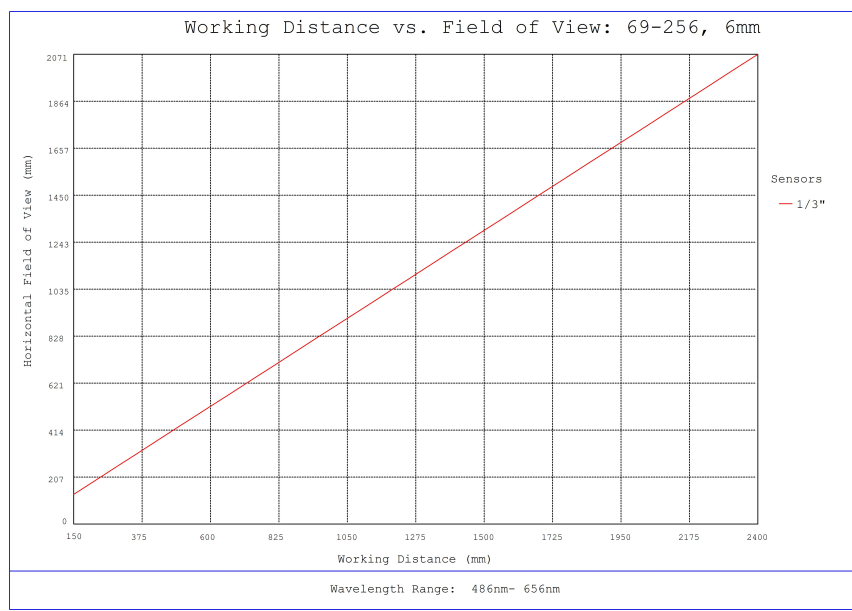

#69-256, f/4, 6mm Focal Length Green Series M12 Lens, Working Distance versus Field of View Plot

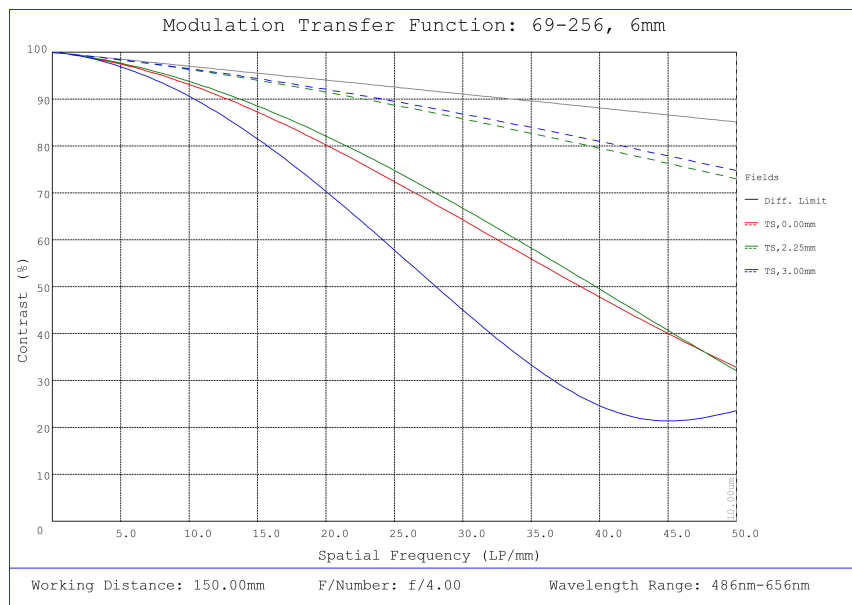

#69-256, f/4, 6mm Focal Length Green Series M12 Lens, Modulated Transfer Function (MTF) Plot, 150mm Working Distance, f4

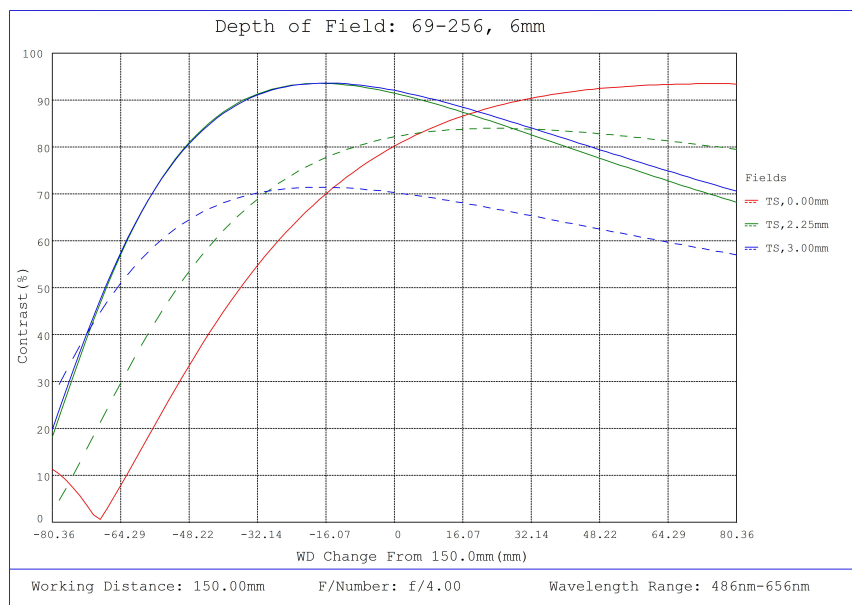

#69-256, f/4, 6mm Focal Length Green Series M12 Lens, Depth of Field Plot, 150mm Working Distance, f4

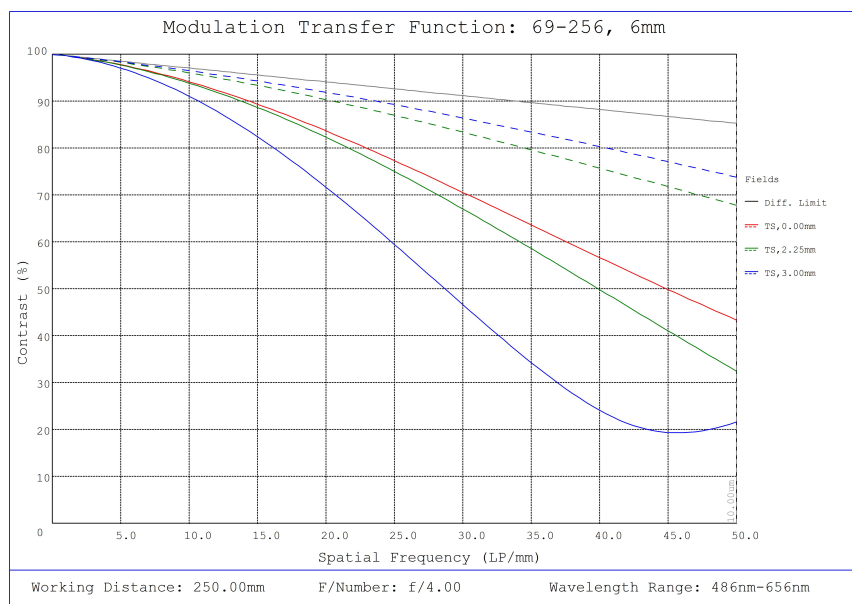

#69-256, f/4, 6mm Focal Length Green Series M12 Lens, Modulated Transfer Function (MTF) Plot, 250mm Working Distance, f4

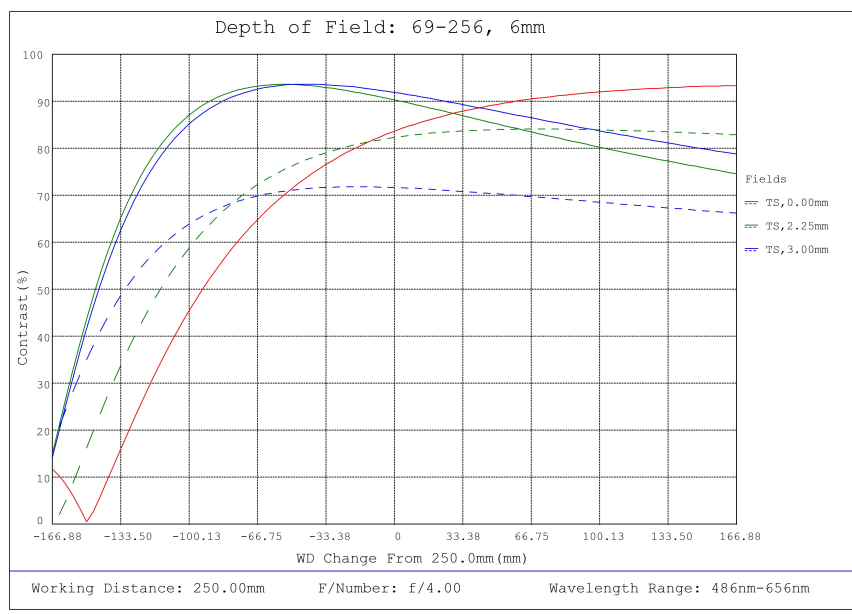

#69-256, f/4, 6mm Focal Length Green Series M12 Lens, Depth of Field Plot, 250mm Working Distance, f4

Focal Length	A	B	C*	D	Mounting Thread
6.00	14.0	11.70	4.0 - 3.9	3.5	M12 x 0.5
8.00	14.0	20.40	8.9 - 8.7	6.0	M12 x 0.5
12.00	16.0	19.50	7.1 - 6.75	6.0	M12 x 0.5
25.00	18.0	24.40	12.6 - 11.9	9.0	M16 x 0.5

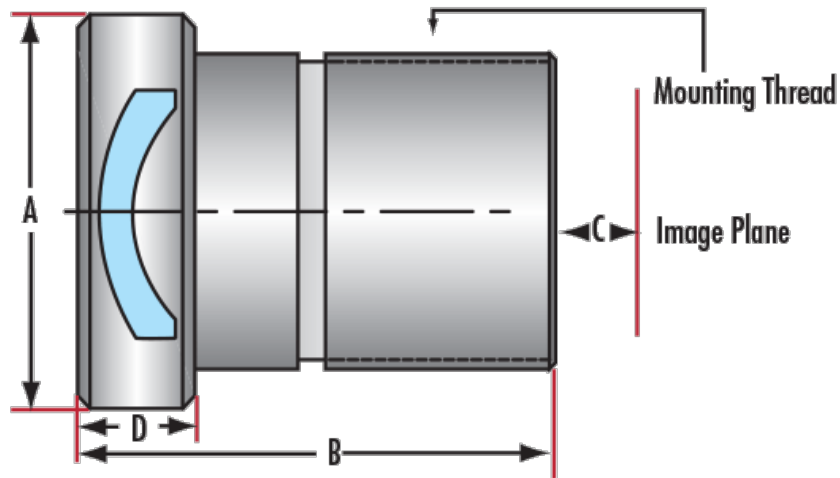

\*\*Minor adjustment required to match WD limits.