

[See all 29 Products in Family](#)

TECHSPEC® Mounting Clamp, 280mm Bolt Circle Diameter

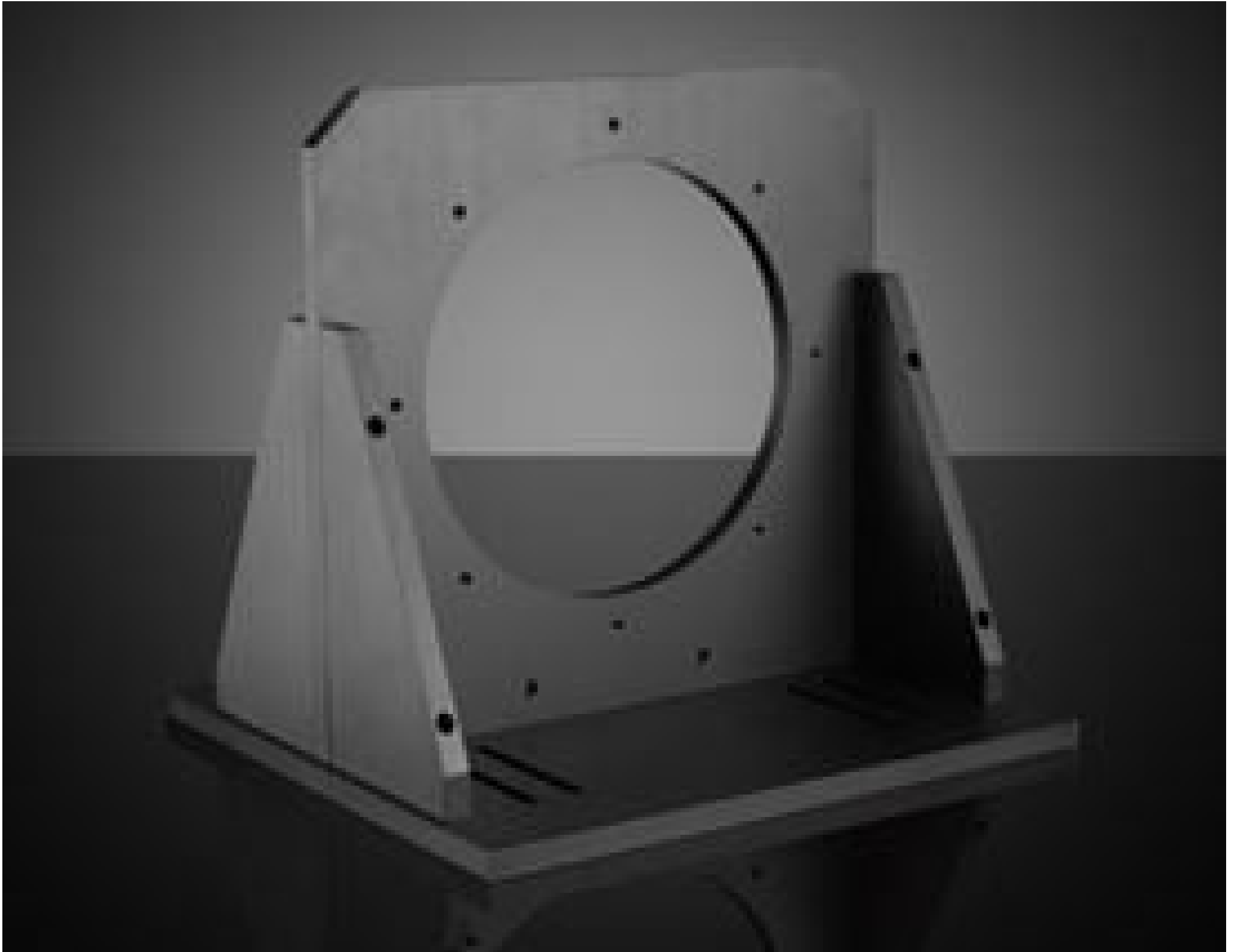

Image shows 28-641



Stock **#28-642** **12 In Stock**

⊖ 1 ⊕ €1.555⁰⁰

ADD TO CART

Volume Pricing	
Qty 1+	€1.555,00 each
Need More?	Request Quote

i Prices shown are exclusive of VAT/local taxes

Product Downloads

General

Note:

Includes mounting hardware and ball drivers

Physical & Mechanical Properties

280 Inner Diameter (mm):

Construction:

216.2 Centerline Height (mm):

Regulatory Compliance

View Certificate of Conformance:

Product Details

- Large Field of View Telecentric Lens
- Up to 31.4 MegaPixels, 3.45µm Pixel Size Sensors
- Full Frame (35mm), C-Mount, T-Mount, M58-Mount, F-Mount Telecentric Lens
- Magnification from 0.037X to 0.377X

TECHSPEC® TitanTL® Telecentric Lenses are designed for machine vision systems and metrology applications that require a large field of view. These lenses feature large maximum sensor formats, a variety of working distance and magnification options, and a rear filter holder on the back of the lenses to allow for easy filter integration. On our 118mm, 182mm and 242mm FOV versions, the integrated mounting flange allows for ease of securing each lens without requiring an additional mount and provides an easy to locate reference plane. TECHSPEC® TitanTL® Telecentric Lenses contain shims that provide adjustment for variation in camera sensor location, an adjustable iris and a 3 set screw lens mount for simple rotational alignment to the camera. Typical applications include automotive and electronic inspection, measurement and gauging applications.

These lenses won the [Silver Level 2017 Innovators Award](#).

Note: Detailed inspection reports included with each lens.

Technical Information

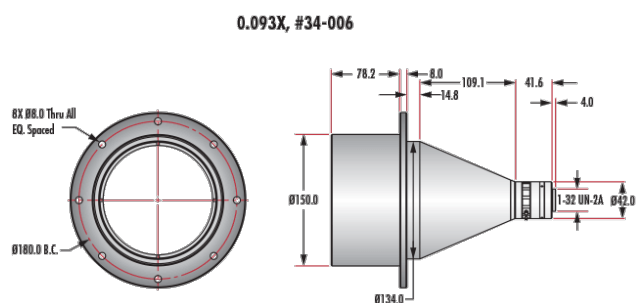
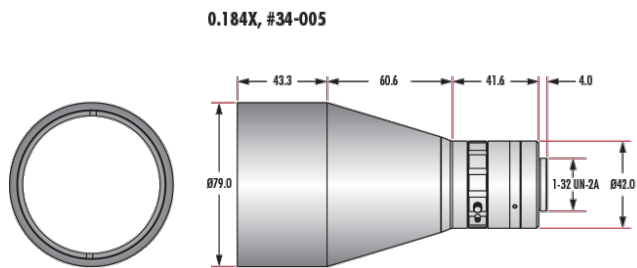
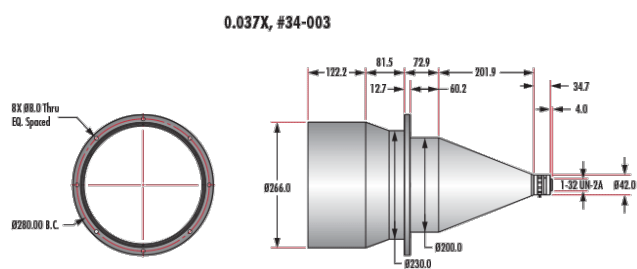
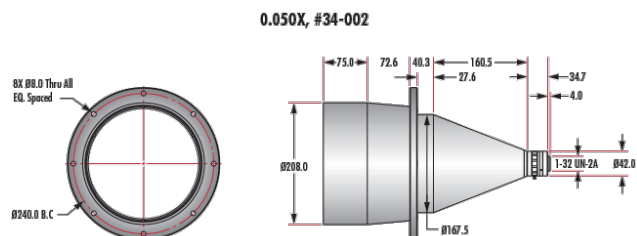
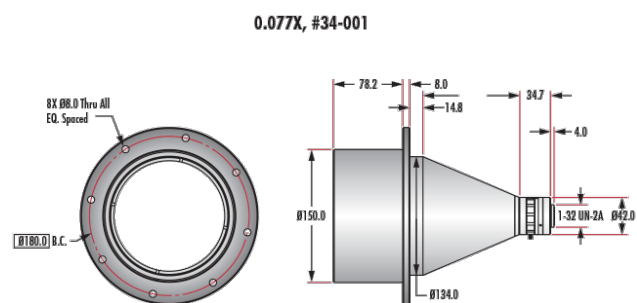
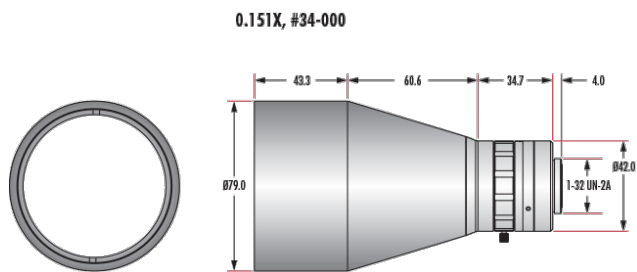

0.060X, #34-007

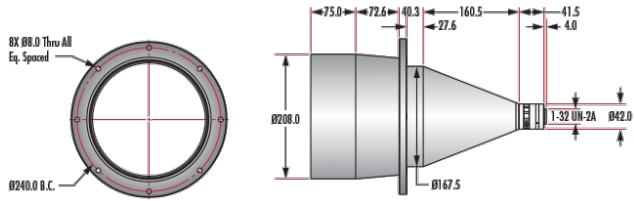

0.045X, #34-008

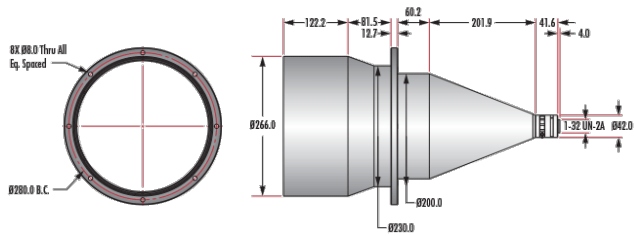

0.268X, #34-010

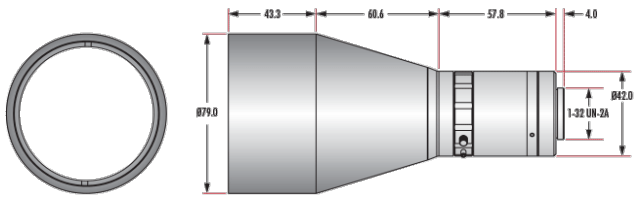

0.136X, #34-011

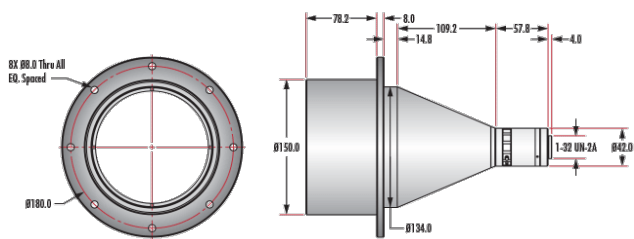

0.088X, #34-012

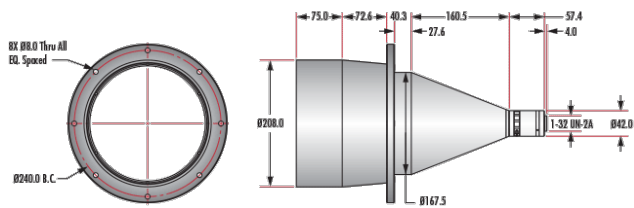

0.066X, #34-013

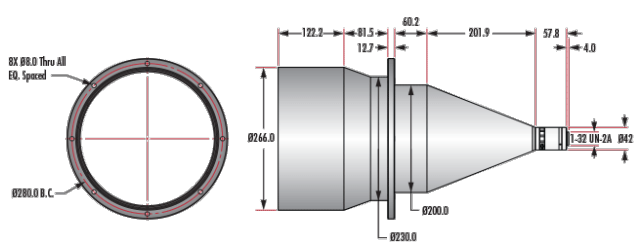

0.377X, #34-015

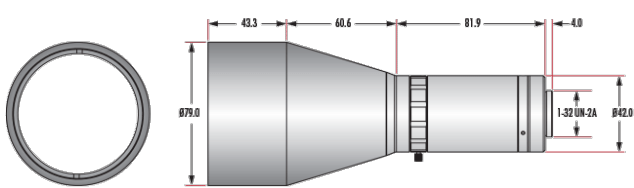

0.191X, #34-016

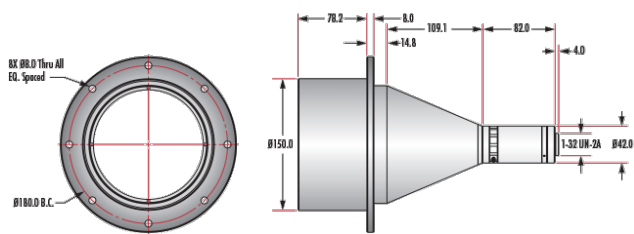

0.124X, #34-017

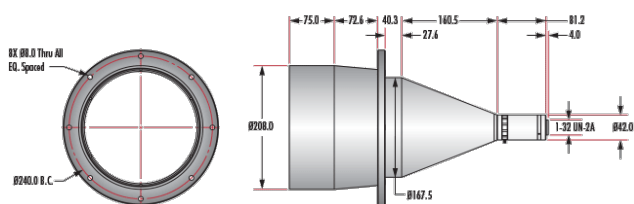

0.093X, #34-018

