

[See all 41 Products in Family](#)

Olympus LMPLFLN 10X Objective

See More by [Olympus](#)



Olympus MPlan Fluorite Semi Apochromat Infinity Corrected Objectives

Stock **#88-203** **1 In Stock**

⊖ 1 ⊕ €1.945⁰⁰

ADD TO CART

Volume Pricing	
Qty 1+	€1.945,00 each
Need More?	Request Quote

ⓘ Prices shown are exclusive of VAT/local taxes

Product Downloads

General

Model Number:
LMPLFLN10X

Compatible Tube Lens Focal Length (mm):
Focal Length: 180mm

Type:
Brightfield

Style:
Infinity Corrected

Olympus
Manufacturer:

Physical & Mechanical Properties

26.00 Diameter (mm):

2.65 Field of View (mm):

24.00 Length excluding Threads (mm):

26 Maximum Diameter (mm):

54 Weight (g):

Optical Properties

N/A Compatible Cover Glass Thickness (mm):

18.00 Focal Length FL (mm):

10X Magnification:

0.25 Numerical Aperture NA:

1.34 Resolving Power (μm):

4.40 Depth of Field (μm):

21.0 Working Distance (mm):

400 - 700 Wavelength Range (nm):

26.5 Field Number (mm):

45 Parfocal Length (mm):

N/A Immersion Liquid:

9.00 Entrance Pupil Diameter (mm):

Threading & Mounting

RMS / 20.32mm x 36 TPI Mounting Threads:

Regulatory Compliance

[View](#) Certificate of Conformance:

Product Details

- Ideal for Brightfield, DIC, Fluorescence, or Polarization Microscopy
- Long Working Distances Reduce Risk of Specimen Damage
- Excellent Transmission from 400 – 700nm
- Additional [Olympus Infinity Corrected Objectives](#) Available

Olympus MPlan Fluorite Semi Apochromat Infinity Corrected Objectives are ideal for a range of applications utilizing a variety of illumination methods. Olympus MPlan Fluorite Semi Apochromat Infinity Corrected Objectives offer long working distances to increase specimen safety, in addition to increased contrast for observation. These objectives feature standard pupil positions, which enable the use of multiple [prisms](#) or [polarizers](#) for differential interference contrast (DIC) optical microscopy applications.

Technical Information

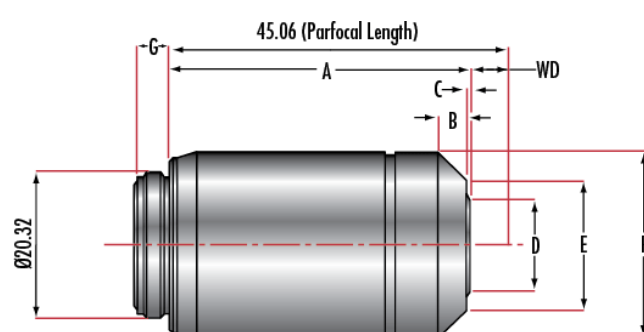

Typical Transmission



Using Olympus Objectives with C-Mount Cameras



Stock #	Model	A	B	C	D	E	F	G	WD
#88-202	LMPLFLN 5X	22.5	0.3	-	25.4	-	26.0	4.9	22.5
#88-203	LMPLFLN 10X	24.0	1.9	-	15.2	22.4	26.0	4.5	21.0
#88-204	LMPLFLN 20X	33.0	3.7	-	17.0	-	26.0	4.8	12.0
#88-205	LMPLFLN 50X	34.4	4.0	-	18.2	-	26.0	4.9	10.6
#88-206	LMPLFLN 100X	41.6	3.8	0.5	12.5	18.1	26.0	4.7	3.4
#16-880	MPLFLN 1.25X	41.5	-	-	28.6	29.0	30	4.9	3.5
#39-573	MPLFLN 2.5X	34.3	2.7	-	24.5	29.0	30.0	4.9	10.7
#88-332	MPLFLN 5X	25.0	2.5	-	20.9	-	26.0	4.5	20.0
#88-333	MPLFLN 10X	34.0	5.6	-	14.5	-	26.0	4.5	11.0
#23-721	M X PLFLN 20X	42.0	2.63	2.15	9	20.4	26	4.8	3
#23-722	M X PLFLN 50X	42.0	3.4	1.96	10.3	19	26	4.5	3



Stock #	Model	A	B	C	D	E	F	G	WD
#86-827	LMPLFLN-BD 5X	30.0	2.6	3.4	16.2	29.5	32.0	5.0	15.0
#86-828	LMPLFLN-BD 10X	35.0	2.1	2.7	15.5	30.0	32.0	4.5	10.0
#86-829	LMPLFLN-BD 20X	33.0	1.2	0.5	22.0	30.0	32.0	4.5	12.0
#86-830	LMPLFLN-BD 50X	34.4	1.2	1.4	20.7	28.0	32.0	4.8	10.6
#86-831	LMPLFLN-BD 100X	41.7	1.2	4.0	21.0	29.0	32.0	4.7	3.3

