

VZM™ 600i Zoom Imaging Lens



VZM™ 600i

Stock #88-399 **14 In Stock**

⊖ 1 ⊕ €1.370⁰⁰

ADD TO CART

Volume Pricing

Qty 1+	€1.370,00 each
Need More?	Request Quote

ⓘ Prices shown are exclusive of VAT/local taxes

Product Downloads

General

High Magnification Zoom Lens **Type:**

Physical & Mechanical Properties

148.05 **Length excluding Threads (mm):**

30.00 **Maximum Diameter (mm):**

Weight (g):

Optical Properties

Horizontal Field of View, 2/3" Sensor:
8.8 - 1.4mm

Horizontal Field of View, 1/2" Sensor:
6.4 - 1.0mm

Working Distance Tolerance (mm):
±3

Resolution, Object Space:
87 lp/mm - 176 lp/mm

Resolution, Image Space:
87 lp/mm - 29 lp/mm

Zoom Ratio:
6:1

Primary Magnification PMAG:
1.0X - 6.0X

Working Distance (mm):
60.00

Lens Wavelength Range:
VIS

Sensor

Maximum Sensor Format:
2/3"

Threading & Mounting

Filter Thread:
M22.5 x 0.50

Mount:
C-Mount

Regulatory Compliance

RoHS 2015:
[Compliant](#)

Certificate of Conformance:
[View](#)

Product Details

- Designed to Accomodate up to 2/3" Sensor Size Formats
- Dependable, Versatile Performance in Compact Designs
- Analog and Digital [Imaging Systems](#) Available

VZM™ Zoom Imaging Lenses enable inspection of a wide range of objects without the inconvenience of changing working distances. In addition, the parfocal zoom allows magnifications to be easily changed without refocusing. These economical lenses are available in working distances ranging from 35mm to 175mm and offer a maximum 2/3" sensor format. Iris versions (i-series) all have locking iris, front filter thread, removable mounting flange, and optional zoom lock. All lenses have a 50mm diameter flange (removable on iris versions except 450i Right Angle) for mounting. VZM™ Zoom Imaging Lenses are ideal for inspection of integrated circuits and solder joints. Also suited for quality control and laboratory inspection needs, as well as surface analysis.

Technical Information

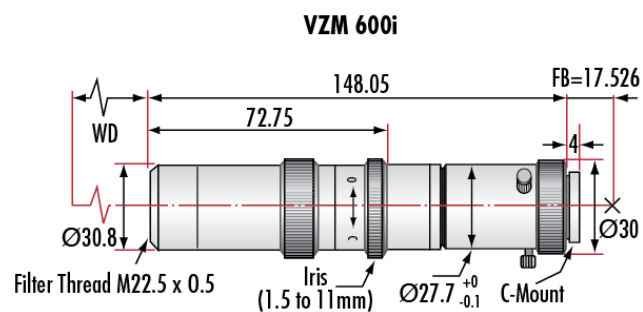

VZM Model	100i	200i	300	300i	450	450i	600i	1000	1000i
Zoom Ratio	4:1	4:1	4:1	4:1	6.4:1	6:1	6:1	4:1	4:1
Magnification	0.25 - 1X	0.5 - 2X	0.75 - 3X	0.75 - 3X	0.7 - 4.5X	0.75 - 4.5X	1 - 6X	2.5 - 10X	2.5 - 10X
Manual Iris	<input type="checkbox"/>	<input type="checkbox"/>		<input type="checkbox"/>		<input type="checkbox"/>	<input type="checkbox"/>		<input type="checkbox"/>
Rotatable Mount	<input type="checkbox"/>	<input type="checkbox"/>		<input type="checkbox"/>		<input type="checkbox"/>	<input type="checkbox"/>		<input type="checkbox"/>
Zoom Lock Adapter	<input type="checkbox"/>	<input type="checkbox"/>		<input type="checkbox"/>		<input type="checkbox"/>	<input type="checkbox"/>		<input type="checkbox"/>
Motorized Version			<input type="checkbox"/>		<input type="checkbox"/>			<input type="checkbox"/>	
Right Angle Version						<input type="checkbox"/>			

Primary Magnification	With 0.5X Lens	
	Minimum 0.25X	Maximum 1.0X
FOV (1/2" Horizontal Sensor)	24.0mm	6.0mm
Resolution in Object Space	10 lp/mm	40 lp/mm
Resolution in Image Space	40 lp/mm	40 lp/mm
Working Distance (±3mm)	152mm	152mm

Primary Magnification	With 0.5X Lens	
	Minimum 0.35X	Maximum 2.25X
FOV (1/2" Horizontal Sensor)	17.6mm	2.8mm
Resolution in Object Space	12 lp/mm	80 lp/mm
Resolution in Image Space	34 lp/mm	35.5 lp/mm
Working Distance (±3mm)	147mm	147mm

Primary Magnification	With 0.5X Lens		With 0.25X Lens	
	Minimum 0.35X	Maximum 2.25X	Minimum 0.175X	Maximum 1.125X
FOV (1/2" Horizontal Sensor)	17.6mm	2.8mm	35.2mm	5.6mm
Resolution in Object Space	12 lp/mm	80 lp/mm	6 lp/mm	40 lp/mm
Resolution in Image Space	34 lp/mm	35.5 lp/mm	34 lp/mm	35.5 lp/mm
Working Distance (±3mm)	147mm	147mm	275mm	275mm

;